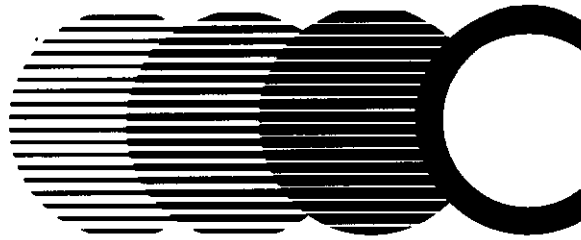

TABLE OF CONTENTS

	<u>Page</u>
GROUP 1: Engine.....	1
GROUP 2: Cooling.....	11
GROUP 3: Electrical	14
GROUP 4: Fuel - Exhaust - Emission	24
GROUP 5: Clutch.....	31
GROUP 6: Transmission	T1
GROUP 7: Shift.....	34
GROUP 8: Brake	36
GROUP 9: Axle - Propeller Shaft.....	44
GROUP 10: Steering - Suspension	59
GROUP 11: Springs - Shocks - Suspension	63
GROUP 12: Hoods - Fenders - Bumpers	67
GROUP 13: Heater	68
GROUP 15: Mirrors.....	68
GROUP 16: Auto Transmission	69
GROUP 18: Transfer Case	69
Transfer Case (Charts)	TC1
GROUP 22: Windshield Wiper.....	70
Index	71
Kit Section.....	76



Crown Automotive Sales Co., Inc.

Independent Distributor of Replacement Parts for Jeep® Vehicles

FAST REFERENCE PARTS CATALOG

JEEP® VEHICLES 1979-1990



CHEROKEE



WAGONEER



J10, J20 PICKUP



COMANCHE

PLEASE NOTE:

Part numbers listed in this catalog are for reference purposes only. No implication is given that parts ordered from Crown will necessarily be the original equipment replacement. In addition, no implication is given that all parts listed are currently stocked by Crown Automotive. No guarantee is given as to the accuracy of this catalog. This catalog is intended as a fast reference book for the convenience of our customers.

Please note that part numbers listed are primarily targeted for vehicles sold in the United States. There may be some discrepancies in vehicles built for export, California and/or with 2WD. In these cases, please consult original equipment catalogs for proper fit.

Crown Automotive Sales Co. Inc.
is not affiliated with Daimler-Chrysler Corporation.

Copyright © 1991 Crown Automotive Sales Co., Inc.

All right reserved. No parts of this catalog may be reproduced in any form or by any means.

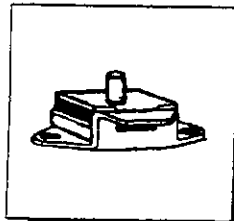

1.009

INSULATOR, Front Engine Mounting

6 Cyl : SJ, 1979-90 use J8128488
 8 Cyl : SJ, 1979-80 use J3226821
 8 Cyl : SJ, 1981-85 use J3213534
 8 Cyl : SJ, 1986-90 use J3219194

4 Cyl : XJ, 1984-90 use 52000074
 V6 Cyl : XJ, 1984-86 use 52000141
 I6 Cyl : XJ, 1987-90 use 52040267
 Diesel : XJ, 1984-90 use 52000957

NOTE: 1. FOR LEFT SIDE. FOR RIGHT SIDE USE J3242711.

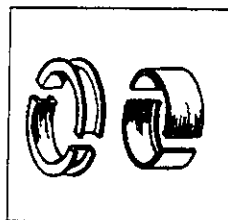

1.023

BEARING, Main - .010

1,2,4,5 (6,7)

6 Cyl : SJ, 1979-80 use J3207957
 6 Cyl : SJ, 1981-90 use J8133254
 8 Cyl : SJ, 1979-90 use J8125931

4 Cyl : XJ, 1984-90 use J8133254
 V6 Cyl : XJ, 1984-86 use 83501965^{1,2}
 I6 Cyl : XJ, 1987-90 use J8133254
 Diesel : XJ, 1984-90 use T1348543³

NOTE: 1. .032 MM.
 2. #2 USE 83501966 (.032 MM).
 3. SET OF 5 BEARINGS.



1.022

CAP, Oil Filler

6 Cyl : SJ, 1979 use J3174645
 6 Cyl : SJ, 1980 use J3236687
 6 Cyl : SJ, 1981-82 use J3238659
 6 Cyl : SJ, 1983-90 use 33001016
 8 Cyl : SJ, 1979-90 use J3220248

4 Cyl : XJ, 1984-90 use 33001016
 V6 Cyl : XJ, 1984-86 use 33001284
 I6 Cyl : XJ, 1987-90 use 33001016
 Diesel : XJ, 1984-90 use T0721928

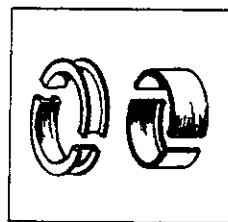

1.023

BEARING, Main - STD

3

6 Cyl : SJ, 1979-80 use J3207959
 6 Cyl : SJ, 1981-90 use J8133253
 8 Cyl : SJ, 1979-90 use J8125933

4 Cyl : XJ, 1984-90 use J8133253
 V6 Cyl : XJ, 1984-86 use 83501968
 I6 Cyl : XJ, 1987-90 use J8133253

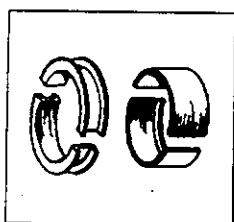

1.023

BEARING, Main - STD

1,2,4,5 (6,7)

6 Cyl : SJ, 1979-80 use J3207954
 6 Cyl : SJ, 1981-90 use J8133252
 8 Cyl : SJ, 1979-90 use J8125928

4 Cyl : XJ, 1984-90 use J8133252
 V6 Cyl : XJ, 1984-86 use 83501962¹
 I6 Cyl : XJ, 1987-90 use J8133252
 Diesel : XJ, 1984-90 use T1348542²

NOTE: 1. #2 USE 83501963.
 2. SET OF 5 BEARINGS - ADD T1348320 TO COMPLETE.

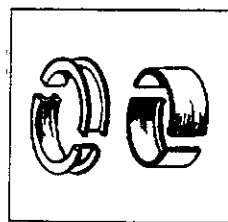

1.023

BEARING, Main - .010

3

6 Cyl : SJ, 1979-80 use J3207962
 6 Cyl : SJ, 1981-90 use J8133255
 8 Cyl : SJ, 1979-90 use J8125936

4 Cyl : XJ, 1984-90 use J8133255
 V6 Cyl : XJ, 1984-86 use 83501970¹
 I6 Cyl : XJ, 1987-90 use J8133255

NOTE: 1. .032 MM.

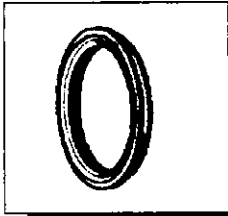

1.032

SEAL KIT, Rear Main Bearing Cap

6 Cyl : SJ, 1979-90 use J3205331
 8 Cyl : SJ, 1979-90 use J3206691

 4 Cyl : XJ, 1984-90 use J3241669
 V6 Cyl : XJ, 1984-86 use 83501888
 I6 Cyl : XJ, 1987-90 use J3205331
 Diesel : XJ, 1984-90 use T1349596

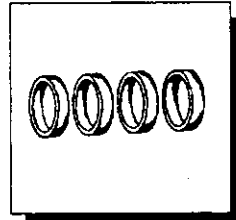

1.041

BEARING SET, Camshaft - .010

6 Cyl : SJ, 1979-90 use J3208985
 6 Cyl : SJ, 1983-86 use J4486890

 4 Cyl : XJ, 1984-90 use J3208985
 I6 Cyl : XJ, 1987-90 use J3208985

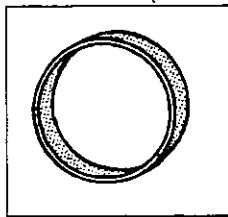

1.038

PLUG, Cylinder Block

6 Cyl : SJ, 1979-85 use J3105394 ¹
 6 Cyl : SJ, 1986-90 use J3178449
 8 Cyl : SJ, 1979-90 use J3144641 ²

 4 Cyl : XJ, 1984-90 use J4006580 ³
 V6 Cyl : XJ, 1984-86 use 83500708
 I6 Cyl : XJ, 1987-90 use J3178449 ³
 Diesel : XJ, 1984-90 use T3075044

NOTE: 1. FOR 2". FOR 7/8" USE J3172319.
 FOR 1" USE J3178449.
 2. FOR 1-1/2". FOR 1-3/4" USE J4006580.
 3. FOR 2.125" USE J3172313. FOR 2" USE
 J3105394.

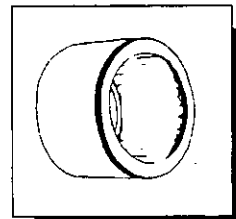

1.043

BUSHING, Crankshaft (Pilot)

6 Cyl : SJ, 1979 use J3213751
 6 Cyl : SJ, 1980-90 use J3236726
 8 Cyl : SJ, 1979 use J3213751
 8 Cyl : SJ, 1980-90 use J3236726

4 Cyl : XJ, 1984-90 use 53000832 ¹
 V6 Cyl : XJ, 1984-86 use 83500786
 I6 Cyl : XJ, 1987-90 use 33004041
 Diesel : XJ, 1984-90 use T3090310

NOTE: 1. W/ MANUAL TRANS USE J3250005.

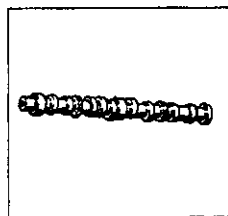

1.040

CAMSHAFT

6 Cyl : SJ, 1979-80 use J8120663 ¹
 6 Cyl : SJ, 1981-90 use J8133009
 8 Cyl : SJ, 1979-85 use J8121156 ²

 4 Cyl : XJ, 1984-90 use 83500249
 V6 Cyl : XJ, 1984-86 use 83500767
 I6 Cyl : XJ, 1987-90 use 83503402
 Diesel : XJ, 1984-90 use T0699231

NOTE: 1. FOR AUTO TRANS USE J8126514.
 2. FOR 304, 1979-80 USE J8129668.

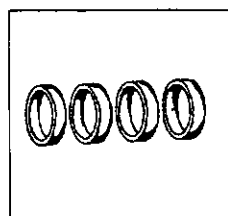

1.041

BEARING SET, Camshaft - STD

6 Cyl : SJ, 1979-90 use J3205711
 8 Cyl : SJ, 1979-90 use J4486286

 4 Cyl : XJ, 1984-90 use J3205711
 I6 Cyl : XJ, 1987-90 use J3205711

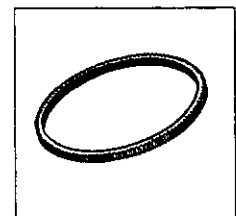

1.056

**GEAR, Flywheel Ring
 with Manual Transmission**

6 Cyl : SJ, 1979-90 use J3179741
 8 Cyl : SJ, 1979-90 use J3179741

4 Cyl : XJ, 1984-90 use J3241718
 V6 Cyl : XJ, 1984-86 use 83500795
 I6 Cyl : XJ, 1987-90 use J3179741
 Diesel : XJ, 1984-90 use T0664055

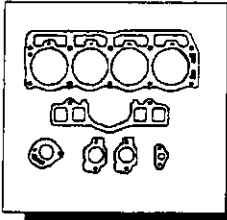

GASKET SET, Engine Valve Grind (Upper)

6 Cyl : SJ, 1979-80 use J8128190
 6 Cyl : SJ, 1981-85 use J8133352
 6 Cyl : SJ, 1986-90 use 83502384
 8 Cyl : SJ, 1979-90 use J8128192 †

1.060

4 Cyl : XJ, 1984-85 use 83500255
 4 Cyl : XJ, 1986 use 83502501
 4 Cyl : XJ, 1987-90 use 83504346
 V6 Cyl : XJ, 1984 use 83500847
 V6 Cyl : XJ, 1985-86 use 83502133
 I6 Cyl : XJ, 1987 use 83503410
 I6 Cyl : XJ, 1988-90 use 83505141
 Diesel : XJ, 1984-90 use T1461765

NOTE: 1. FOR 304 THRU 1981 USE J8128191.

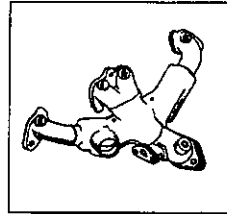

MANIFOLD, Exhaust

6 Cyl : SJ, 1979 use J8124999
 6 Cyl : SJ, 1980 use J3236582
 6 Cyl : SJ, 1981-82 use J3237427
 6 Cyl : SJ, 1983-90 use J3237426
 8 Cyl : SJ, 1979 use J8122442 †
 8 Cyl : SJ, 1980-90 use J8129210 †

1.067

4 Cyl : XJ, 1984-90 use 33002509
 V6 Cyl : XJ, 1984-87 use 83500794
 I6 Cyl : XJ, 1986-90 use 53006244
 Diesel : XJ, 1984-90 use T0723183

NOTE: 1. FOR LEFT SIDE. FOR RIGHT SIDE USE J8121274.

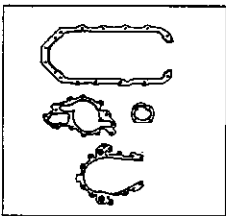

GASKET SET, Engine Lower

6 Cyl : SJ, 1979-80 use J8125722
 6 Cyl : SJ, 1981-90 use J8133353
 8 Cyl : SJ, 1979-90 use J8125727

1.060

4 Cyl : XJ, 1984-87 use 83500256
 4 Cyl : XJ, 1988-90 use 83504647
 V6 Cyl : XJ, 1984 use 83500848
 V6 Cyl : XJ, 1985-86 use 83502134
 I6 Cyl : XJ, 1987-90 use 83505389
 Diesel : XJ, 1984-90 use T1461334

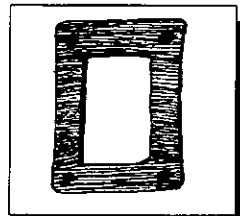

GASKET, Intake Manifold to Exhaust Manifold

6 Cyl : SJ, 1979-80 use J3184277
 8 Cyl : SJ, 1979-90 use J8125869 †

1.067

V6 Cyl : XJ, 1984-86 use 83500828
 Diesel : XJ, 1984-90 use T0694729

NOTE: 1. COMPLETE SET, INCLUDING SEALS.

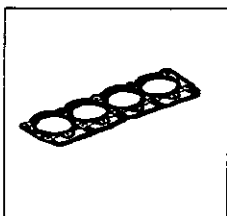

GASKET, Cylinder Head

6 Cyl : SJ, 1979-80 use J3228469
 6 Cyl : SJ, 1981-85 use J3237756
 6 Cyl : SJ, 1986-90 use J3228469
 8 Cyl : SJ, 1979-80 use J3219846 †
 8 Cyl : SJ, 1981-90 use J3227352

1.061

4 Cyl : XJ, 1984-85 use J3241649
 4 Cyl : XJ, 1986 use 33002419
 4 Cyl : XJ, 1987-90 use 33003722
 V6 Cyl : XJ, 1984 use 83500731
 V6 Cyl : XJ, 1985-86 use 83502172
 I6 Cyl : XJ, 1987-90 use 33004447
 Diesel : XJ, 1984-90 use T1028289 ‡

NOTE: 1. FOR 304 THRU 1981 USE J3197636.
 2. FOR 1.6MM. FOR 1.7MM USE T0711666.
 FOR 1.8MM USE T1028290.

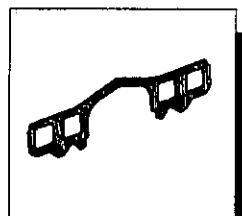

GASKET, Intake Manifold to Cylinder Head

6 Cyl : SJ, 1979-80 use J3183945
 6 Cyl : SJ, 1981-85 use J3237775
 6 Cyl : SJ, 1986-90 use J3242855

1.067

4 Cyl : XJ, 1984-90 use J3242854
 V6 Cyl : XJ, 1986 use 53006529 †
 I6 Cyl : XJ, 1987-90 use 53006529 †
 Diesel : XJ, 1984-90 use T1348923 †

NOTE: 1. GASKET FOR BOTH, INTAKE AND EXHAUST MANIFOLD.

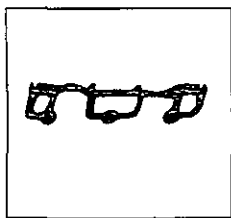

GASKET, Exhaust Manifold to
Cylinder Head

8 Cyl : SJ, 1980-90 use J3237270

4 Cyl : XJ, 1984-90 use 53006529

1.067

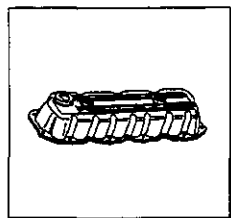

COVER KIT, Cylinder Head
(Includes Gasket & All Necessary
Hardware)

6 Cyl : SJ, 1981-85 use 83501398K

1.068

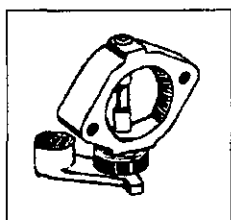

DAMPER KIT, Exhaust Manifold

6 Cyl : SJ, 1979-80 use J8125076

8 Cyl : SJ, 1979-90 use J3238998

1.067

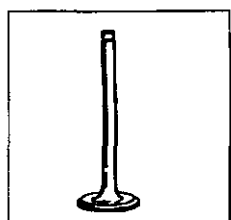

VALVE, Intake - STD

6 Cyl : SJ, 1979-80 use J3218732

6 Cyl : SJ, 1981-85 use J3237465

6 Cyl : SJ, 1986-90 use J3240768

304 : SJ, 1979-80 use J3218732

304 : SJ, 1981 use J3237465

360 : SJ, 1979-90 use J3229657

1.077

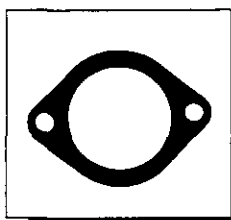

GASKET, Exhaust Manifold Damper

8 Cyl : SJ, 1979 use J5353073

1.067

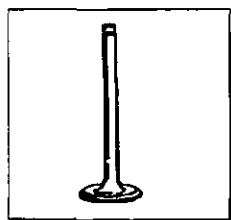

VALVE, Intake - .003

6 Cyl : SJ, 1979-80 use J3218809

6 Cyl : SJ, 1981-90 use J3240166

8 Cyl : SJ, 1981-90 use J8127694

4 Cyl : XJ, 1984-86 use J3242670

4 Cyl : XJ, 1987-90 use 33003519

V6 Cyl : XJ, 1984-86 use 83500740

I6 Cyl : XJ, 1987-90 use 33003519

1.077

NOTE: 1. .089mm

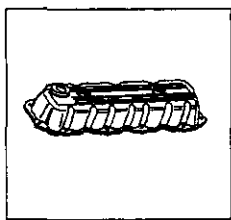

COVER, Cylinder Head

6 Cyl : SJ, 1979 use J3231912

6 Cyl : SJ, 1980 use J3236706

6 Cyl : SJ, 1981-85 use 83501398

6 Cyl : SJ, 1986-90 use 33003688

8 Cyl : SJ, 1979-87 use J3233719

8 Cyl : SJ, 1988-90 use 53007906

1.068

4 Cyl : XJ, 1984-86 use J3242121

4 Cyl : XJ, 1987-90 use 33003857

V6 Cyl : XJ, 1984-86 use 83500757

I6 Cyl : XJ, 1987-90 use 83505594

Diesel : XJ, 1984-90 use T0717274

NOTE: 1. FOR ENGINE WITH 5 MOUNTING BOLTS
USE 33002393.

2. FOR RIGT SIDE. FOR LEFT SIDE USE
83500758.

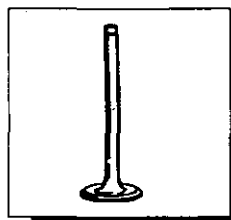

VALVE, Intake - .015

6 Cyl : SJ, 1979-80 use J3218810

6 Cyl : SJ, 1981-90 use J3240167

8 Cyl : SJ, 1981-90 use J8127695

4 Cyl : XJ, 1984-86 use J3242671

4 Cyl : XJ, 1987-90 use 33003575

V6 Cyl : XJ, 1984-86 use 83500741

I6 Cyl : XJ, 1987-90 use 33003575

1.077

NOTE: 1. .394mm. FOR .775MM USE
83500742.

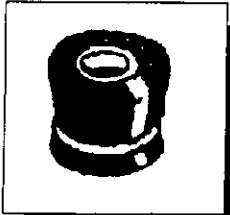

1.077

SEAL, Intake Valve (Deflector) - STD

6 Cyl : SJ, 1979-86 use J3205878
 6 Cyl : SJ, 1987-90 use J3218976

 4 Cyl : XJ, 1984-90 use 33002729
 V6 Cyl : XJ, 1984-87 use 83500748
 I6 Cyl : XJ, 1986-90 use 33002729

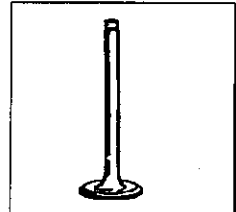

1.078

VALVE, Exhaust - .015

6 Cyl : SJ, 1979-80 use J3223978
 6 Cyl : SJ, 1981-90 use J3240164
 8 Cyl : SJ, 1981-90 use J3224605

 4 Cyl : XJ, 1984-85 use J3242674
 4 Cyl : XJ, 1986 use 83502492
 4 Cyl : XJ, 1987-90 use 33003576
 V6 Cyl : XJ, 1984-86 use 83500745
 I6 Cyl : XJ, 1987-90 use 33003576

NOTE: 1. .394mm. FOR .775MM USE
 83500746.

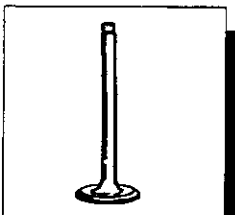

1.078

VALVE, Exhaust - STD

6 Cyl : SJ, 1979-80 use J3224597
 6 Cyl : SJ, 1981-85 use J3237464
 6 Cyl : SJ, 1986-90 use J3240767
 304 : SJ, 1979-80 use J3224597
 304 : SJ, 1981 use J3237464
 360 : SJ, 1979-90 use J3224598

4 Cyl : XJ, 1984-85 use J3242896
 4 Cyl : XJ, 1986 use 33002429
 4 Cyl : XJ, 1987-90 use 33003860
 V6 Cyl : XJ, 1984-86 use 83500743
 I6 Cyl : XJ, 1987-90 use 33003860
 Diesel : XJ, 1984-90 use T1461339

NOTE: 1. WITH VALVE ROTATORS USE
 J3223969.

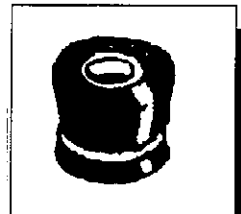

1.078

SEAL, Exhaust Valve (Deflector) - STD

6 Cyl : SJ, 1979-86 use J3205878
 6 Cyl : SJ, 1987-90 use J3218976

 4 Cyl : XJ, 1984-90 use 33002522
 I6 Cyl : XJ, 1986-90 use 33002522

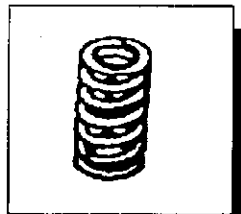

1.083

SPRING, Valve

6 Cyl : SJ, 1979-90 use J3228192
 8 Cyl : SJ, 1979-90 use J3228192

 4 Cyl : XJ, 1984-90 use J3242678
 V6 Cyl : XJ, 1984-86 use 83500747
 I6 Cyl : XJ, 1987-90 use J3242678

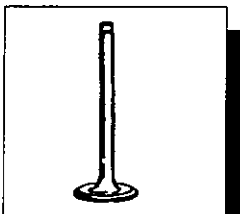

1.078

VALVE, Exhaust - .003

6 Cyl : SJ, 1979-80 use J3223977
 6 Cyl : SJ, 1981-90 use J3240163
 8 Cyl : SJ, 1981-90 use J3224604

4 Cyl : XJ, 1984-85 use J3242673
 4 Cyl : XJ, 1986 use 83502491
 4 Cyl : XJ, 1987-90 use 33003520
 V6 Cyl : XJ, 1984-87 use 83500744
 I6 Cyl : XJ, 1986-90 use 33003520

NOTE: 1. W/O VALVE ROTATORS USE J3224602.
 2. .089mm

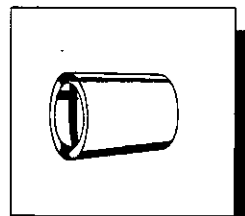

1.085

LOCK, Valve Spring Retainer

6 Cyl : SJ, 1979-80 use J3156157
 6 Cyl : SJ, 1981-90 use J3180458
 8 Cyl : SJ, 1979-90 use J3156157

 4 Cyl : XJ, 1984-90 use 33003521
 V6 Cyl : XJ, 1984-86 use 83500755
 I6 Cyl : XJ, 1987-89 use 33003521

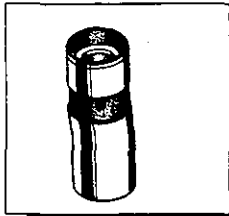

1.088

TAPPET, Valve (with Snap Ring)

6 Cyl : SJ, 1979-90 use J3222276
8 Cyl : SJ, 1979-90 use J3222276

4 Cyl : XJ, 1984-90 use J3222276
V6 Cyl : XJ, 1984-86 use 83500766
I6 Cyl : XJ, 1986-90 use J3222276

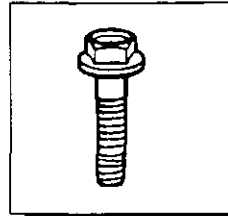

1.101

BOLT, Pivot to Cylinder Head

6 Cyl : SJ, 1979-90 use J8120512
8 Cyl : SJ, 1979-90 use J8120512

4 Cyl : XJ, 1984-90 use J8120512
V6 Cyl : XJ, 1984-86 use 83500763
I6 Cyl : XJ, 1987-90 use J8120512

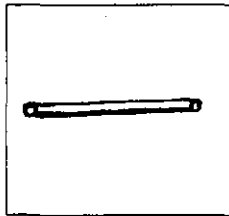

1.095

ROD, Valve Push

6 Cyl : SJ, 1979-80 use J3227329
6 Cyl : SJ, 1981-90 use J3242395
8 Cyl : SJ, 1979-90 use J3214014

4 Cyl : XJ, 1984-90 use J3241709
V6 Cyl : XJ, 1984-86 use 83500762
I6 Cyl : XJ, 1987-90 use 33002986

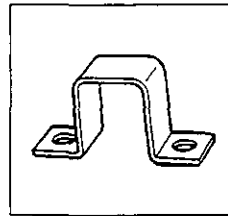

1.101

BRIDGE, Rocker Arm

6 Cyl : SJ, 1980-90 use J3236513
8 Cyl : SJ, 1980-90 use J3236513

4 Cyl : XJ, 1984-90 use J3236513
I6 Cyl : XJ, 1986-90 use J3236513

NOTE: 1. WITH COVER STUD USE J3237851.

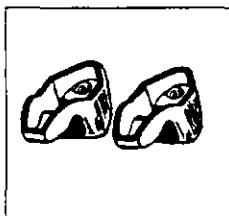

1.097

ARM, Valve Rocker

6 Cyl : SJ, 1979-82 use J3223888
6 Cyl : SJ, 1983-90 use J3242393
8 Cyl : SJ, 1979-90 use J3223539

4 Cyl : XJ, 1984-90 use J3242393
V6 Cyl : XJ, 1984-86 use 83500756
I6 Cyl : XJ, 1987-90 use J3242393
Diesel : XJ, 1984-90 use T6009641

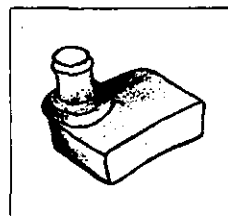

1.116

FILTER, Cylinder Head Cover to Air Cleaner Hose

6 Cyl : SJ, 1979 use J3236695

4 Cyl : XJ, 1984-90 use J3236695
V6 Cyl : XJ, 1984-86 use 53000715

NOTE: 1. CARBURETED ENGINE ONLY.

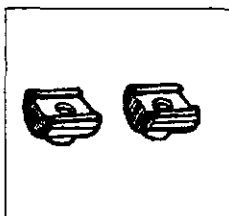

1.101

PIVOT, Valve Rocker Arm

6 Cyl : SJ, 1979 use J3210178
6 Cyl : SJ, 1980-90 use J3235090
8 Cyl : SJ, 1979 use J3210178
8 Cyl : SJ, 1980-90 use 3235090

4 Cyl : XJ, 1984-90 use J3235090
I6 Cyl : XJ, 1987-90 use J3235090

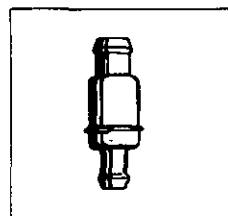

1.119

PCV VALVE, Positive Crankcase Ventilation

6 Cyl : SJ, 1979-80 use J3236680
6 Cyl : SJ, 1981 use J3240359
6 Cyl : SJ, 1982-90 use J3241629
8 Cyl : SJ, 1979-90 use J3234216

4 Cyl : XJ, 1984-87 use 33001239
V6 Cyl : XJ, 1984-87 use 53000960

NOTE: 1. WITH VALVE & ELBOW USE 33000887.

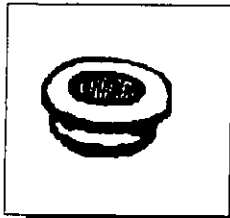

1.119

GROMMET, Cylinder Head Cover

6 Cyl : SJ, 1979-80 use J3225627
 6 Cyl : SJ, 1981-90 use J3237765
 4 Cyl : XJ, 1984-90 use J3237765
 V6 Cyl : XJ, 1984-86 use 83500832
 I6 Cyl : XJ, 1987-90 use 53004722

NOTE: 1. WITH .08" HOLE USE 53004721.
 WITH .45" HOLE USE 33001237.
 2. FOR RIGHT SIDE USE 53000957.

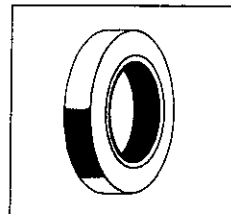

1.123

SEAL, Timing Case Cover

6 Cyl : SJ, 1979-90 use J3224704
 8 Cyl : SJ, 1979-90 use J3193613
 4 Cyl : XJ, 1984-90 use J3224704
 V6 Cyl : XJ, 1984-86 use 83501487
 I6 Cyl : XJ, 1987-90 use J3224704

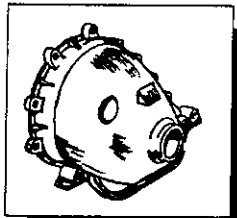

1.120

COVER ASSY, Timing Case

6 Cyl : SJ, 1979-85 use J3225186
 6 Cyl : SJ, 1986-87 use 33002984
 6 Cyl : SJ, 1988-90 use 53005769
 8 Cyl : SJ, 1979-90 use J8129373
 4 Cyl : XJ, 1984-85 use J3243096
 4 Cyl : XJ, 1986-87 use 33002984
 4 Cyl : XJ, 1988-90 use 53005769
 V6 Cyl : XJ, 1984-86 use 83500728
 I6 Cyl : XJ, 1987 use 33002984
 I6 Cyl : XJ, 1988-90 use 53005769

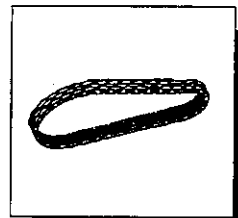

1.130

CHAIN, Timing

6 Cyl : SJ, 1979-90 use J3240502
 8 Cyl : SJ, 1979 use J3185270
 8 Cyl : SJ, 1980-90 use J3234433
 4 Cyl : XJ, 1984-90 use J3242300
 V6 Cyl : XJ, 1984-86 use 83500799
 I6 Cyl : XJ, 1987-90 use 33002977
 Diesel : XJ, 1984-90 use T0663544

NOTE: 1. WITH 1/2" WIDTH USE J3234433.
 2. FOR 1984-85 WITH 5/8" WIDTH USE J8134343.
 3. THIS IS A BELT, NOT A CHAIN.

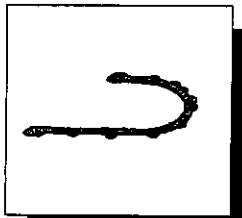

1.121

GASKET, Timing Case Cover

6 Cyl : SJ, 1979-90 use J3225187
 8 Cyl : SJ, 1979-90 use J3180216
 4 Cyl : XJ, 1984-90 use J3225187
 V6 Cyl : XJ, 1984-86 use 83500843
 I6 Cyl : XJ, 1987-90 use J3225187

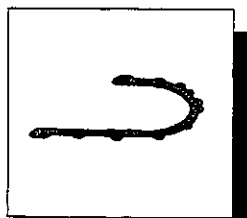

1.121

GASKET SET, Timing Case Cover

6 Cyl : SJ, 1979-90 use J8129097
 8 Cyl : SJ, 1979-90 use J8129098
 4 Cyl : XJ, 1984-90 use J8129097
 I6 Cyl : XJ, 1987-90 use J8129097

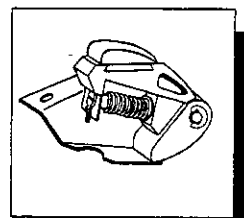

1.131

TENSIONER ASSY, Timing Chain

4 Cyl : XJ, 1984-90 use 33003421

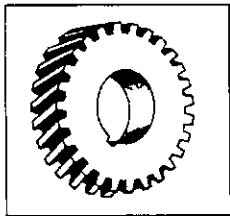

1.132

SPROCKET, Crankshaft

6 Cyl : SJ, 1979-90 use 33004107
 8 Cyl : SJ, 1979 use J3223199¹
 8 Cyl : SJ, 1980-90 use J3234235²
 4 Cyl : XJ, 1984-90 use 33004020
 V6 Cyl : XJ, 1984-87 use 83500800
 I6 Cyl : XJ, 1986-90 use 33002979
 Diesel : XJ, 1984-90 use T1349583

NOTE: 1. WITH 1/2" WIDTH USE J3234235.
 2. FOR 1984-85 WITH 5/8" WIDTH USE J3223199.

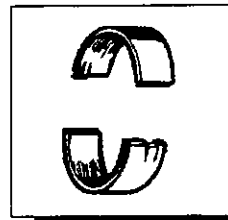

1.138

BEARING, Connecting Rod - STD
 (Upper & Lower)

6 Cyl : SJ, 1979-90 use J8126204
 8 Cyl : SJ, 1979-90 use J8126204
 4 Cyl : XJ, 1984-90 use 83500300
 V6 Cyl : XJ, 1984-86 use 83500774
 I6 Cyl : XJ, 1987-90 use 83500300
 Diesel : XJ, 1984-90 use T1462226¹

NOTE: 1. FOR 56.26MM. SET OF 4.

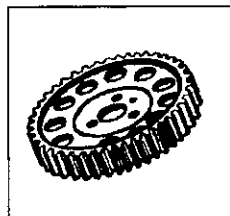

1.134

SPROCKET, Camshaft

6 Cyl : SJ, 1979-90 use J3206693
 8 Cyl : SJ, 1979 use J3197138¹
 8 Cyl : SJ, 1980-90 use J3234234²
 4 Cyl : XJ, 1984-90 use J3242280
 V6 Cyl : XJ, 1984-86 use 83500801
 I6 Cyl : XJ, 1987-90 use 33002978
 Diesel : XJ, 1984-90 use T1349586

NOTE: 1. WITH 1/2" WIDTH USE J3234234.
 2. FOR 1984-85 WITH 5/8" WIDTH USE J3197138.

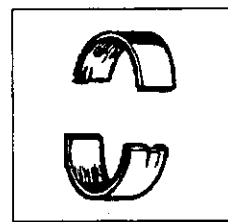

1.138

BEARING, Connecting Rod - .001
 (Upper & Lower)

6 Cyl : SJ, 1979-90 use J8126205
 8 Cyl : SJ, 1979-90 use J8126205
 4 Cyl : XJ, 1984-90 use 83501397
 V6 Cyl : XJ, 1984-86 use 83500775¹
 I6 Cyl : XJ, 1987-90 use 83501397

NOTE: 1. .016MM.

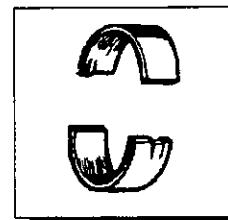

1.138

BEARING, Connecting Rod - .002
 (Upper & Lower)

6 Cyl : SJ, 1979-90 use J8126206
 8 Cyl : SJ, 1979-90 use J8126206

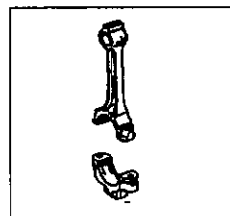

1.136

ROD ASSY, Connecting

6 Cyl : SJ, 1979-82 use J3180444
 6 Cyl : SJ, 1983-90 use J3237812
 8 Cyl : SJ, 1979-82 use J3196750
 8 Cyl : SJ, 1983-90 use J3237814
 4 Cyl : XJ, 1984-87 use J3237816
 4 Cyl : XJ, 1988-90 use 33004545
 V6 Cyl : XJ, 1984-86 use 83500773
 I6 Cyl : XJ, 1987 use J3237816
 I6 Cyl : XJ, 1988-90 use 33004545
 Diesel : XJ, 1984-90 use T1462223

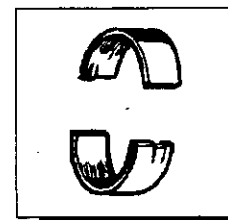

1.138

BEARING, Connecting Rod - .010
 (Upper & Lower)

6 Cyl : SJ, 1979-90 use J8126207
 8 Cyl : SJ, 1979-90 use J8126207
 4 Cyl : XJ, 1984-90 use 83500301
 I6 Cyl : XJ, 1987-90 use 83500301
 Diesel : XJ, 1984-90 use T1462227

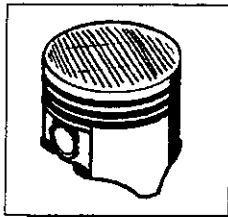

1.143

PISTON, with Pin - STD

6 Cyl : SJ, 1979-82 use J8130208
 6 Cyl : SJ, 1983-90 use J8134441
 8 Cyl : SJ, 1979-81 use J4487567
 8 Cyl : SJ, 1982-90 use J8133807

4 Cyl : XJ, 1984-90 use 83500251
 V6 Cyl : XJ, 1984 use 83500778
 V6 Cyl : XJ, 1985-86 use 83501889
 I6 Cyl : XJ, 1987-90 use 83500251
 Diesel : XJ, 1984-90 use T1463646

NOTE: 1. FOR V8-304 USE J4487564.
 2. FROM ENGINE NO. 3800 AND ON USE
 T1463646. ALL SETS CONTAIN PISTONS, PINS,
 SLEEVES & RING SETS.

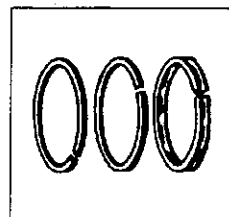

1.146

RING SET, Piston - .010

6 Cyl : SJ, 1979-90 use J8121684
 8 Cyl : SJ, 1979-82 use J3208067

NOTE: 1. FOR 304 ENGINE USE J8121686.

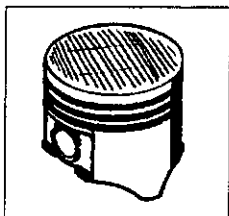

1.143

PISTON, with Pin - .010

4 Cyl : XJ, 1984-90 use 83500252
 I6 Cyl : XJ, 1987-90 use 83500252

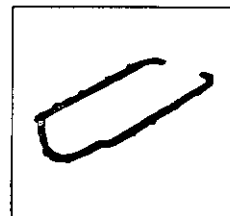

1.152

GASKET SET, Engine Oil Pan

6 Cyl : SJ, 1979-90 use 83504662
 8 Cyl : SJ, 1979-90 use J3206690

4 Cyl : XJ, 1984-87 use 83500270
 4 Cyl : XJ, 1988-90 use 83504661
 V6 Cyl : XJ, 1984 use 83500853
 I6 Cyl : XJ, 1987-90 use 83504662
 Diesel : XJ, 1984-90 use T0695923

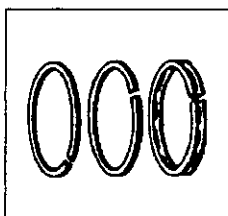

1.146

RING SET, Piston - STD

6 Cyl : SJ, 1979-90 use J8121683
 8 Cyl : SJ, 1979-82 use J3208066

4 Cyl : XJ, 1984-90 use 83500210
 V6 Cyl : XJ, 1984-85 use 83500782
 V6 Cyl : XJ, 1986 use 83501893
 I6 Cyl : XJ, 1987-90 use 83500210
 Diesel : XJ, 1984-90 use T1462255

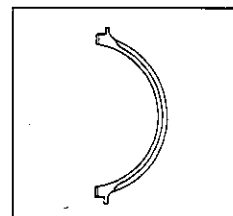

1.152

SEAL, Engine Oil Pan to Bearing Cap Rear

6 Cyl : SJ, 1979-88 use J3177635
 8 Cyl : SJ, 1979-88 use J3177635

4 Cyl : XJ, 1984-90 use J3241609
 V6 Cyl : XJ, 1984-86 use 83501898
 I6 Cyl : XJ, 1987-90 use J3177635

NOTE: 1. FOR 304 ENGINE USE J8121685.

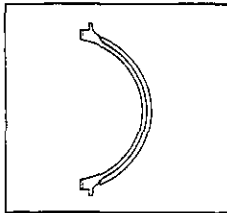

1.152

SEAL, Oil Pan Timing Case Cover Front

6 Cyl : SJ, 1979-86 use J3172848
 8 Cyl : SJ, 1979-88 use J3180414

 4 Cyl : XJ, 1984-87 use J3172848
 4 Cyl : XJ, 1988-90 use 83504654
 I6 Cyl : XJ, 1987 use J3172848
 I6 Cyl : XJ, 1988-90 use 33004733

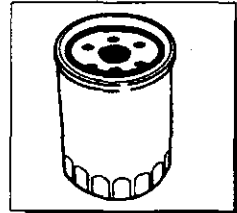

1.206

ELEMENT, Oil Filter

6 Cyl : SJ, 1979-82 use J8133965
 6 Cyl : SJ, 1983-86 use J3242397
 6 Cyl : SJ, 1987-90 use 33004195
 8 Cyl : SJ, 1979-82 use J8993146
 8 Cyl : SJ, 1983-86 use J3242397
 8 Cyl : SJ, 1987-90 use 33004195

 4 Cyl : XJ, 1984-86 use J8132313
 4 Cyl : XJ, 1987-90 use 33004195
 V6 Cyl : XJ, 1984-86 use J8132313
 I6 Cyl : XJ, 1987-90 use 33004195

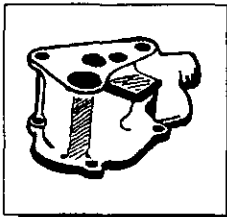

1.154

PUMP ASSY, Engine Oil

6 Cyl : SJ, 1979-80 use J3181340
 6 Cyl : SJ, 1981-82 use J3238637
 6 Cyl : SJ, 1983-90 use J3242141
 8 Cyl : SJ, 1979-90 use J3184086K 1

 4 Cyl : XJ, 1984-85 use J3241602
 4 Cyl : XJ, 1986-90 use J3243102
 V6 Cyl : XJ, 1984 use 83500826
 V6 Cyl : XJ, 1985-86 use 83501486
 I6 Cyl : XJ, 1987-90 use 33002921
 Diesel : XJ, 1984-87 use T6004404
 Diesel : XJ, 1988-90 use T6005270

NOTE: 1. THIS IS AN OIL PUMP REPAIR KIT.

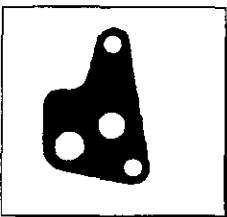

1.165

GASKET, Engine Oil Pump Cover

6 Cyl : SJ, 1979-80 use J3172337
 8 Cyl : SJ, 1979-88 use J3226241

 V6 Cyl : XJ, 1984-86 use 83500831

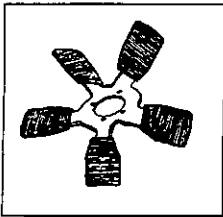

2.002

BLADES, Fan (Radiator)

4 BLADES

6 Cyl : SJ, 1979-86 use J3224499
6 Cyl : SJ, 1987-90 use 52001171

5 BLADES

4 Cyl : XJ, 1984-86 use 53001660
4 Cyl : XJ, 1987-90 use 53000699
V6 Cyl : XJ, 1984-86 use 53001660
Diesel : XJ, 1984-90 use 53001706

6 BLADES

I6 Cyl : XJ, 1987-90 use 83503411 1

7 BLADES

6 Cyl : SJ, 1979-90 use J0994277 2
6 Cyl : SJ, 1981-90 use J5362528 3
6 Cyl : SJ, 1979-90 use J5357390 4

4 Cyl : XJ, 1984-87 use 53001414 3
V6 Cyl : XJ, 1984-86 use 53001415 3
I6 Cyl : XJ, 1987-90 use 52002593 3
I6 Cyl : XJ, 1987-90 use 83504571 2

NOTE: 1. USED WITH ELECTRIC FAN MOTOR.
2. USED WITHOUT S.B.D.
3. USED WITH S.B.D.
4. USED WITHOUT TEMPATROL.

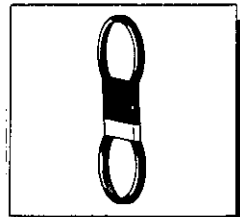

2.015

BELT, Serpentine Drive

56,66,78 AMP - without A.C.; with P.S.

6 Cyl : SJ, 1981-82 use J3239595
6 Cyl : SJ, 1983-90 use J3239594 1

4 Cyl : XJ, 1984-85 use 53001120
4 Cyl : XJ, 1986-90 use 53002900
I6 Cyl : XJ, 1987-90 use 53002899

NOTE: 1. FOR 78 AMP ONLY USE J3239593.

56,66,78 AMP - without A.C.;
without P.S.

6 Cyl : SJ, 1981-82 use J3239594
6 Cyl : SJ, 1983-87 use 33000558

4 Cyl : XJ, 1984-85 use 53001120
4 Cyl : XJ, 1986-90 use 53002900
I6 Cyl : XJ, 1986-90 use 53002899

56,66,70,78 AMP - with A.C.; with P.S.

6 Cyl : SJ, 1981-82 use J3241096 1

4 Cyl : XJ, 1984-90 use 53001120 2
I6 Cyl : XJ, 1986-90 use 53002899

NOTE: 1. FOR 70 AMP ONLY USE J3239590.
2. FOR 70 AMP ONLY, 1986-90, USE
53002900

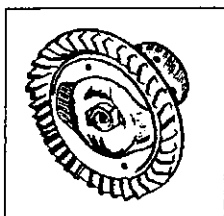

2.004

TEMPATROL

6 Cyl : SJ, 1979 use J0998761
6 Cyl : SJ, 1980 use J5354432
6 Cyl : SJ, 1981-90 use J5362722
8 Cyl : SJ, 1979-80 use J0998761
8 Cyl : SJ, 1981-90 use J5362722

4 Cyl : XJ, 1984-86 use J3241857
4 Cyl : XJ, 1987-90 use J3241858
V6 Cyl : XJ, 1984-86 use J3241856 1
V6 Cyl : XJ, 1984-86 use 53001693 2
I6 Cyl : XJ, 1987 use 52003205
I6 Cyl : XJ, 1988-90 use 83504571
Diesel : XJ, 1984-90 use 53001168

NOTE:
1. 6" DIAMETER.
2. 7.25" DIAMETER.

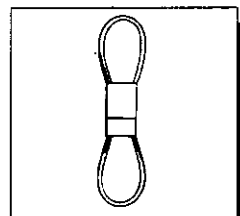

2.015

BELT, Radiator & Alternator Fan
(without Serpentine Belt Drive)

without Air Conditioning

6 Cyl : SJ, 1979-80 use J3223006
6 Cyl : SJ, 1981-90 use J3239615
8 Cyl : SJ, 1979-90 use J3227690

4 Cyl : XJ, 1984-90 use J3239615
V6 Cyl : XJ, 1984-86 use 53001772
Diesel : XJ, 1984-90 use 53000825

with Air Conditioning
without Power Steering

6 Cyl : SJ, 1979-80 use J3224451
6 Cyl : SJ, 1981-85 use J3225356

4 Cyl : XJ, 1984-90 use 83501923
V6 Cyl : XJ, 1984-86 use G9433662
Diesel : XJ, 1984-90 use 53002341

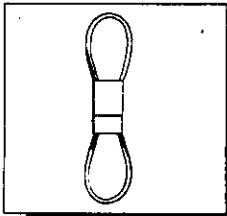

BELT, Radiator & Alternator Fan
(without Serpentine Belt Drive)

with E.E.P.
with Power Steering

6 Cyl : SJ, 1981-90 use J3226936
8 Cyl : SJ, 1981-90 use J3227692

2.016

4 Cyl : XJ, 1984-90 use J3226936
V6 Cyl : XJ, 1984-87 use 53000830
Diesel : XJ, 1984-90 use 53001773

Air Pump (6 Cyl.) & Compressor (4 Cyl.)

4 Cyl : XJ, 1984-87 use 83501924
V6 Cyl : XJ, 1984-86 use G9433653



CAP, Radiator

without Coolant Recovery

6 Cyl : SJ, 1979-90 use J5352954
8 Cyl : SJ, 1979-90 use J5352954

2.032

with Coolant Recovery

6 Cyl : SJ, 1979-90 use J5358177
8 Cyl : SJ, 1979-90 use J5358177

4 Cyl : XJ, 1984-90 use J3239375
V6 Cyl : XJ, 1984-86 use J3239375
I6 Cyl : XJ, 1987-90 use J4401790
Diesel : XJ, 1984-90 use J5364692

NOTE: 1. LOCATED ON COOLANT RECOVERY BOTTLE.

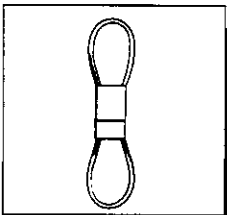

BELT SET, Dual Belt Drive

56.78.94 AMP: w/ Air Conditioning
8 Cyl : SJ, 1979-90 use J3227691

70.85 AMP: w/ Air Conditioning
8 Cyl : SJ, 1979-90 use J5362180

2.016

70.85 AMP: w/o Air Conditioning
8 Cyl : SJ, 1979-90 use J5362181

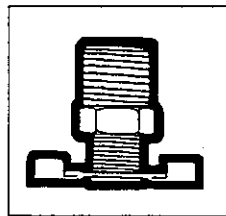

DRAIN COCK, Radiator Core

6 Cyl : SJ, 1979-80 use JA001126
6 Cyl : SJ, 1981-90 use J5359274
8 Cyl : SJ, 1979-80 use JA001126
8 Cyl : SJ, 1981-90 use J5359274

2.036

4 Cyl : XJ, 1984-90 use J3166547
V6 Cyl : XJ, 1984-87 use J3166547
I6 Cyl : XJ, 1986-90 use J3166547
Diesel : XJ, 1984-90 use J3166547

NOTE: 1. THIS IS METAL. FOR PLASTIC USE 83505381.

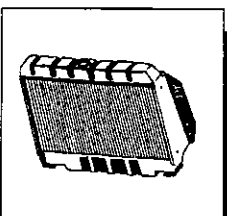

CORE, Radiator - with H.D.C.

6 Cyl : SJ, 1979 use J5359098
6 Cyl : SJ, 1980-85 use J5361576
8 Cyl : SJ, 1979 use J5358061
8 Cyl : SJ, 1980-85 use J5361577

2.020

4 Cyl : XJ, 1984-87 use 53000521
V6 Cyl : XJ, 1984-87 use 53000666
I6 Cyl : XJ, 1986-87 use 56002491
Diesel : XJ, 1984-90 use 53001174

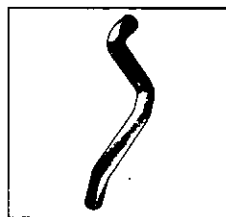

HOSE, Radiator Lower (Outlet)

6 Cyl : SJ, 1979-90 use J5354405
8 Cyl : SJ, 1979-90 use J5354528

2.038

4 Cyl : XJ, 1984-87 use 53000012
4 Cyl : XJ, 1988-90 use 52003790
V6 Cyl : XJ, 1984-86 use 53000014
I6 Cyl : XJ, 1987 use 52003237
I6 Cyl : XJ, 1988-90 use 52003802
Diesel : XJ, 1984-87 use 52002177
Diesel : XJ, 1988-90 use 52003799

NOTE: 1. WITH A.C. INCLUDE BOTH 83505114 & 83505115.

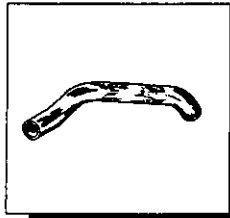

2.038

HOSE, Radiator Upper (Inlet)

6 Cyl : SJ, 1979-80 use J0999105
 6 Cyl : SJ, 1981-90 use J5362698
 8 Cyl : SJ, 1979-87 use J0999632
 8 Cyl : SJ, 1988 use 83503499
 8 Cyl : SJ, 1990 use 83505532

4 Cyl : XJ, 1984-87 use 53001439 ¹
 4 Cyl : XJ, 1988-90 use 52003789 ²
 V6 Cyl : XJ, 1984-86 use 53000013 ³
 I6 Cyl : XJ, 1987 use 52003240 ⁴
 I6 Cyl : XJ, 1988-90 use 52003803 ⁵
 Diesel : XJ, 1984-87 use 52002182
 Diesel : XJ, 1988-90 use 52003800

NOTE:

1. w/o A.C. USE 53000471.
2. WITH A.C. - WITH 24MM WIDE A.C. COMPRESSOR CYLINDER HEAD USE 52003791. WITH 45MM WIDE A.C. COMPRESSOR CYLINDER HEAD USE 52003941.
3. w/o A.C. USE 53000509.
4. w/o A.C. USE 52003250.
5. w/o A.C. USE 52003801.

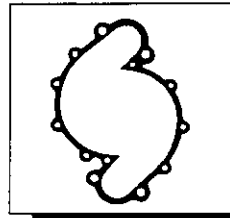

2.098

GASKET, Water Pump

6 Cyl : SJ, 1979-90 use J3173204
 8 Cyl : SJ, 1979-88 use J3181899

4 Cyl : XJ, 1984-90 use J3173204
 V6 Cyl : XJ, 1984-86 use 83500808
 I6 Cyl : XJ, 1987-90 use J3173204

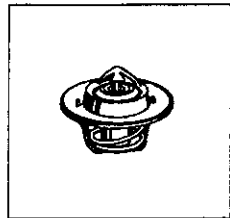

2.100

THERMOSTAT, 195°

6 Cyl : SJ, 1979-82 use J8127383
 6 Cyl : SJ, 1983-85 use 83500360
 6 Cyl : SJ, 1986-90 use 83501426
 8 Cyl : SJ, 1979-90 use J8127383

4 Cyl : XJ, 1984-90 use 83501426
 V6 Cyl : XJ, 1984-86 use 83500813
 I6 Cyl : XJ, 1987-90 use 83501426
 Diesel : XJ, 1984-90 use T0697157

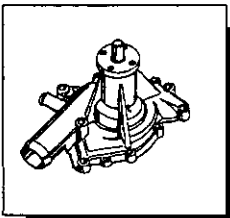

2.080

WATER PUMP, NEW

6 Cyl : SJ, 1979 use J8125501
 6 Cyl : SJ, 1980 use J8130749
 6 Cyl : SJ, 1981-85 use J8133033
 6 Cyl : SJ, 1986-90 use J8134320 ¹
 8 Cyl : SJ, 1979-90 use J3234427

4 Cyl : XJ, 1984-86 use J8134320 ¹
 4 Cyl : XJ, 1987-90 use 83502957 ²
 4 Cyl : XJ, 1987-90 use 83502938 ³
 V6 Cyl : XJ, 1984-86 use 83500807
 I6 Cyl : XJ, 1987-90 use 83503407
 Diesel : XJ, 1984-90 use T1461336

- NOTE:**
1. WITH S.B.D. USE J8134321.
 2. WITHOUT SERPENTINE BELT DRIVE.
 3. WITH SERPENTINE BELT DRIVE.

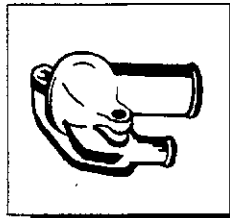

2.102

HOUSING, Thermostat

6 Cyl : SJ, 1979-80 use J3224216
 6 Cyl : SJ, 1981-90 use J3235347
 8 Cyl : SJ, 1979-80 use J3210852
 8 Cyl : SJ, 1981-90 use J3238509

4 Cyl : XJ, 1984-86 use J3235347
 4 Cyl : XJ, 1987 use 33004856
 4 Cyl : XJ, 1988 use 33003612
 4 Cyl : XJ, 1990 use 53005529
 I6 Cyl : XJ, 1987-88 use 33002929
 I6 Cyl : XJ, 1990 use 33004856
 Diesel : XJ, 1984-90 use T0727361

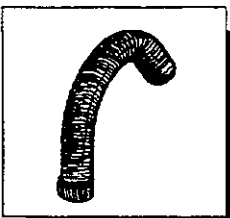

2.080

HOSE, Water Pump to Thermostat Housing Bypass

8 Cyl : SJ, 1979-90 use J3182494

4 Cyl : XJ, 1984-87 use J3241955
 4 Cyl : XJ, 1988 use 52003842
 4 Cyl : XJ, 1989-90 use 52004317
 I6 Cyl : XJ, 1987-90 use 33002508
 Diesel : XJ, 1984-90 use T0661636



2.102

GASKET, Thermostat Housing

6 Cyl : SJ, 1979-90 use J3189874
 8 Cyl : SJ, 1979-88 use J3187543

4 Cyl : XJ, 1984-90 use J3189874
 V6 Cyl : XJ, 1984-86 use 83500855
 I6 Cyl : XJ, 1987-90 use J3189874

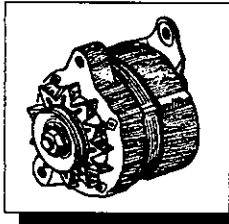

3.016

ALTERNATOR

61 AMP

4 Cyl : XJ, 1987-90 use 53003802 ¹
 16 Cyl : XJ, 1987-90 use 53002897

NOTE: 1. TAGGED 1101175. IF TAGGED 1101171 USE 53004264.

42, 63 AMP

6 Cyl : SJ, 1979-82 use J8127023
 6 Cyl : SJ, 1979-90 use J8134663 ¹
 8 Cyl : SJ, 1979-82 use J8127023
 8 Cyl : SJ, 1979-90 use J8134663 ¹

NOTE: 1. INCLUDING METRIC HARDWARE.

70 AMP

6 Cyl : SJ, 1981-82 use J8133346
 8 Cyl : SJ, 1981-82 use J8133346

74 AMP

4 Cyl : XJ, 1987-90 use 53003803 ¹

NOTE: 1. TAGGED 1101176. IF TAGGED 1101172 USE 53004265.

78 (56-66) AMP

6 Cyl : SJ, 1983-90 use J8134664
 8 Cyl : SJ, 1983-90 use J8134664

4 Cyl : XJ, 1984-90 use J8134664
 V6 Cyl : XJ, 1984-86 use J8134664

85 AMP

6 Cyl : SJ, 1983-90 use J8134666
 8 Cyl : SJ, 1983-90 use J8134666

16 Cyl : XJ, 1987-90 use 53002898

94 AMP

8 Cyl : SJ, 1987-90 use 83505104

100 AMP

16 Cyl : XJ, 1987-90 use 53002897

60 AMP (Diesel)

Diesel : XJ, 1984-90 use 53001762

70 AMP (Diesel)

Diesel : XJ, 1984-90 use 53001764

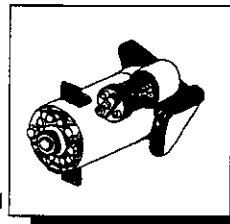

3.020

MOTOR, Starting

6 Cyl : SJ, 1979-80 use J3231371
 6 Cyl : SJ, 1981-86 use J5752791
 6 Cyl : SJ, 1987-90 use 33002709
 8 Cyl : SJ, 1979-80 use J3231371
 8 Cyl : SJ, 1981-86 use J5752791
 8 Cyl : SJ, 1987-90 use 33002709

4 Cyl : XJ, 1984-90 use J3242283 ¹
 4 Cyl : XJ, 1986 use 53002125 ²
 4 Cyl : XJ, 1987-90 use 83503480
 V6 Cyl : XJ, 1984-86 use 53002124
 16 Cyl : XJ, 1987-90 use 33002709
 Diesel : XJ, 1984-90 use 53002577

NOTE: 1. WITH CARBURETED ENGINE.
 2. WITH FUEL INJECTION.

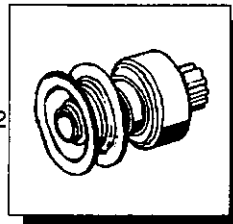

3.020

DRIVE ASSY, Starter

6 Cyl : SJ, 1979-87 use J8120193
 6 Cyl : SJ, 1987-90 use 83503662
 8 Cyl : SJ, 1979-87 use J8120193 ¹
 8 Cyl : SJ, 1987-90 use 83503662 ³

4 Cyl : XJ, 1984-90 use 83500399
 4 Cyl : XJ, 1987-90 use 83501498 ²
 V6 Cyl : XJ, 1984-86 use J8130940
 16 Cyl : XJ, 1987-90 use 83503662
 Diesel : XJ, 1984-90 use 83502041

NOTE: 1. WITH FORD TYPE STARTER.
 2. WITH BOSCH TYPE STARTER.
 3. WITH MITSUBISHI TYPE STARTER.

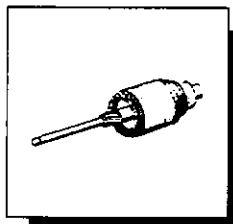

3.020

ARMATURE, Starter

6 Cyl : SJ, 1979-90 use J8120028
 8 Cyl : SJ, 1979-90 use J8120028

4 Cyl : XJ, 1984-90 use 83500396 ¹
 4 Cyl : XJ, 1987-90 use 83501588 ²
 V6 Cyl : XJ, 1984-86 use J8134198 ³
 Diesel : XJ, 1984-90 use 83502039

NOTE: 1. WITH FORD TYPE STARTER.
 2. WITH BOSCH TYPE STARTER.
 3. WITH TAG #'s 1998427-1998524 USE 83501382.

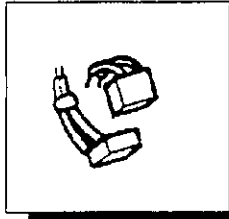

3.020

BRUSH KIT, Starter

6 Cyl : SJ, 1979-87 use J8128434
 6 Cyl : SJ, 1987-90 use 83503670 ³
 8 Cyl : SJ, 1979-87 use J8128434
 8 Cyl : SJ, 1987-90 use 83503670 ³

4 Cyl : XJ, 1984-90 use 83502055 ¹
 4 Cyl : XJ, 1987-90 use 83504108 ²
 V6 Cyl : XJ, 1984-86 use J8130933
 I6 Cyl : XJ, 1987-90 use 83503670 ³
 Diesel : XJ, 1984-90 use 83502055

NOTE: 1. CONSISTS OF 83500401 (+) AND 83500402 (-). WITH FORD TYPE STARTER.
 2. WITH BOSCH TYPE STARTER.
 3. WITH MITSUBISHI TYPE STARTER.

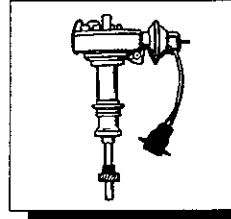

3.030

DISTRIBUTOR, Without Cap & Rotor

6 Cyl : SJ, 1979 use J3232434 ¹
 6 Cyl : SJ, 1980-81 use J3235141 ^{2,3}
 6 Cyl : SJ, 1982-90 use 83506286
 304 : SJ, 1979 use J3233959 ⁴
 304 : SJ, 1980-81 use J3237198 ⁵
 360 : SJ, 1979-90 use J3233174

4 Cyl : XJ, 1984-85 use J3242700 ⁶
 4 Cyl : XJ, 1986-90 use J3243066 ⁹
 4 Cyl : XJ, 1986-90 use 53002107 ¹⁰
 V6 Cyl : XJ, 1984 use 83500948 ⁷
 V6 Cyl : XJ, 1985-86 use 83501494 ⁸
 I6 Cyl : XJ, 1987-90 use 53007190 ¹¹

NOTE:
 1. WITH DUAL THROAT CARB USE J3231915.
 2. WITH HIGH ALTITUDE COMPENSATION USE J3237200.
 3. WITH 1981, MANUAL TRANSMISSION USE J3238428.
 4. WITH MANUAL TRANS USE J3234693.
 5. WITH 1980 AUTOMATIC TRANSMISSION USE J3237199.
 6.
 7. WITH MANUAL TRANS USE 83500947.
 8. WITH MANUAL TRANS USE 83501493.
 9. WITH CARBURETED ENGINE.
 10. WITH FUEL INJECTION.
 11. WHEN TAG INDICATES, USE 33004589.

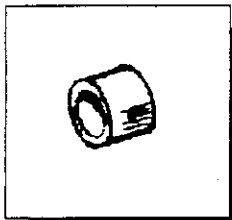

3.020

BUSHING, Starter, Drive End

6 Cyl : SJ, 1979-87 use J8120030
 8 Cyl : SJ, 1979-87 use J8120030

4 Cyl : XJ, 1984-87 use J8120030 ¹
 4 Cyl : XJ, 1987-90 use 83501499 ²
 V6 Cyl : XJ, 1984-86 use J8130954
 Diesel : XJ, 1984-90 use 83502052

NOTE: 1. WITH FORD TYPE STARTER.
 2. WITH BOSCH TYPE STARTER.

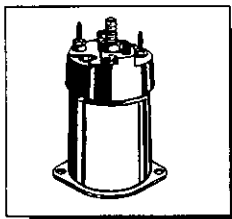

3.024

RELAY, Starting Motor (Solenoid)

6 Cyl : SJ, 1979 use J3235898
 6 Cyl : SJ, 1980-90 use J5752125 ⁴
 8 Cyl : SJ, 1979 use J3235898
 8 Cyl : SJ, 1980-90 use J5752125 ⁴

4 Cyl : XJ, 1984-90 use J5752125 ^{1,4}
 4 Cyl : XJ, 1987-90 use 83504107 ²
 V6 Cyl : XJ, 1984-86 use J8133925 ³
 I6 Cyl : XJ, 1987-90 use 83503655
 Diesel : XJ, 1984-90 use 83502879

NOTE:
 1. WITH FORD TYPE STARTER.
 2. WITH BOSCH TYPE STARTER.
 3. WITH TAG # 1109535 USE 83500937.
 4. WITH MANUAL TRANS USE J3235898.

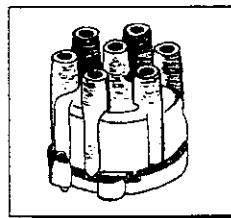

3.032

CAP, Distributor

6 Cyl : SJ, 1979-90 use J3230457
 8 Cyl : SJ, 1979-90 use J3230757

4 Cyl : XJ, 1984-90 use J3234451
 V6 Cyl : XJ, 1984-86 use 83500934
 I6 Cyl : XJ, 1987-90 use 33004024

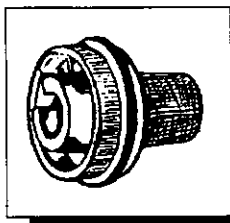

3.035

ROTOR, Distributor

6 Cyl : SJ, 1979-90 use J3230821
 8 Cyl : SJ, 1979-90 use J3230765

 4 Cyl : XJ, 1984-88 use J3234452
 4 Cyl : XJ, 1989 use 33004795
 V6 Cyl : XJ, 1984-86 use 83501085
 I6 Cyl : XJ, 1987-89 use 33003389

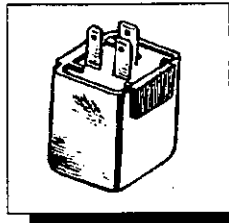

3.125

RELAY, Horn

6 Cyl : SJ, 1979-82 use J5456647
 6 Cyl : SJ, 1983-90 use J5764039
 8 Cyl : SJ, 1979-82 use J5456647
 8 Cyl : SJ, 1983-90 use J5764039

 4 Cyl : XJ, 1984-90 use J5764039
 V6 Cyl : XJ, 1984-86 use J5764039
 I6 Cyl : XJ, 1987-90 use J5764039
 Diesel : XJ, 1984-90 use J5764039

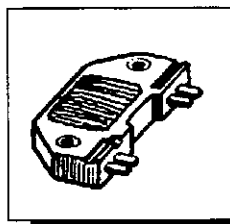

3.044

MODULE, Solid State Ignition

6 Cyl : SJ, 1979-90 use 33004065
 8 Cyl : SJ, 1979-90 use 33004065

 4 Cyl : XJ, 1984-87 use 33004065
 4 Cyl : XJ, 1986-90 use 33002299
 V6 Cyl : XJ, 1984-86 use J8134117
 I6 Cyl : XJ, 1987-90 use 33002299

NOTE: 1. WITH FUEL INJECTION.

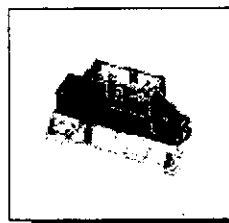

3.130

SWITCH, Ignition (w/o Cylinder)

6 Cyl : SJ, 1979-90 use J3250576¹
 8 Cyl : SJ, 1979-90 use J3250576¹

 ALL XJ, 1984-90 use J3250576¹

NOTE: 1. WITH ADJUSTING WHEEL USE J3250575.

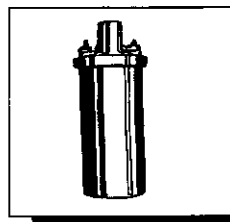

3.056

COIL, Ignition

6 Cyl : SJ, 1979-85 use J3230427
 6 Cyl : SJ, 1986-90 use 33004522
 8 Cyl : SJ, 1979-85 use J3230427
 8 Cyl : SJ, 1986-90 use 33004522

 4 Cyl : XJ, 1984-87 use J3230427¹
 4 Cyl : XJ, 1986-90 use T1031135²
 V6 Cyl : XJ, 1984 use J8134003
 V6 Cyl : XJ, 1985-86 use 83501871
 I6 Cyl : XJ, 1987-90 use T1031135

NOTE: 1. WITH CARBURETED ENGINE.
 2. WITH FUEL INJECTION.

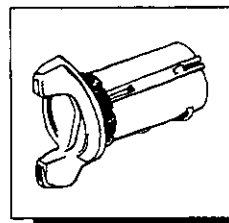

3.135

CYLINDER, with Tumblers, Springs, Retainer & Keys

6 Cyl : SJ, 1979-90 use 8120081K
 8 Cyl : SJ, 1979-90 use 8120081K

 4 Cyl : XJ, 1984-85 use 8120081K
 4 Cyl : XJ, 1986-87 use 83501971
 V6 Cyl : XJ, 1984-85 use 8120081K
 V6 Cyl : XJ, 1986 use 83501971
 I6 Cyl : XJ, 1987-90 use 83501971
 Diesel : XJ, 1984-85 use 8120081K
 Diesel : XJ, 1986-90 use 83501971

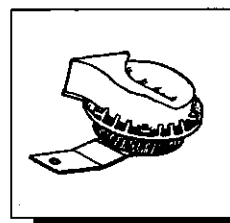

3.105

HORN, Low Pitch

6 Cyl : SJ, 1979-90 use J5758484
 8 Cyl : SJ, 1979-90 use J5758484

 4 Cyl : XJ, 1984-90 use J5758484
 V6 Cyl : XJ, 1984-86 use J5758484
 I6 Cyl : XJ, 1986-90 use J5758484
 Diesel : XJ, 1984-86 use J5758484
 Diesel : XJ, 1987 use 56002378
 Diesel : XJ, 1988-90 use J5758484

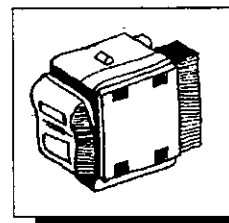

3.145

SWITCH, Lighting

6 Cyl : SJ, 1979-85 use J5751098
 6 Cyl : SJ, 1986-90 use 56001861
 8 Cyl : SJ, 1979-85 use J5751098
 8 Cyl : SJ, 1986-90 use 56001861

 ALL XJ, 1984-90 use 56001197

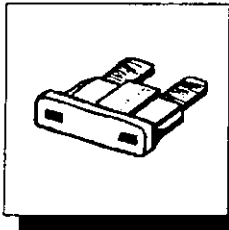

FUSE

3 AMP use J3231211
 10 AMP use J3231215
 15 AMP use J3231216
 20 AMP use J3231217
 25 AMP use J3231218

3.155

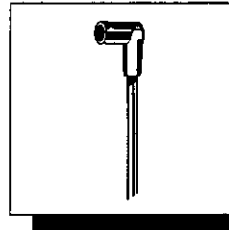

COIL WIRE, Ignition

6 Cyl : SJ, 1987-90 use 83300144
 4 Cyl : XJ, 1984-90 use J3242842 1
 4 Cyl : XJ, 1986-90 use 53002157 2
 V6 Cyl : XJ, 1984-86 use 83500945
 I6 Cyl : XJ, 1987-90 use 53002157

3.228

NOTE: 1. WITH CARBURETED ENGINE.
 2. WITH FUEL INJECTION.

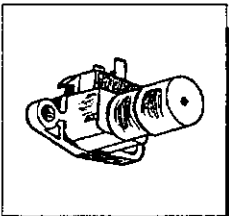

SWITCH, Headlight Dimmer

6 Cyl : SJ, 1979-85 use J5461816 1
 6 Cyl : SJ, 1986-90 use J3239703 2
 8 Cyl : SJ, 1979-85 use J5461816 1
 8 Cyl : SJ, 1986-90 use J3239703 2
 4 Cyl : XJ, 1984-90 use J3239703 2
 V6 Cyl : XJ, 1984-86 use J3239703 2
 I6 Cyl : XJ, 1987-90 use J3239703 2

3.158

NOTE: 1. FLOOR MOUNTED.
 2. ON STEERING COLUMN.

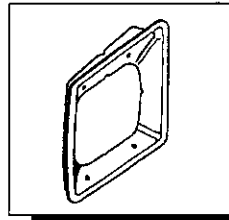

BEZEL, Headlamp

Chrome - Left

6 Cyl : SJ, 1981-90 use J5764143
 8 Cyl : SJ, 1981-90 use J5764143

3.252

4 Cyl : XJ, 1984-90 use 55002245 1
 V6 Cyl : XJ, 1984-86 use 55002245 1
 I6 Cyl : XJ, 1987-90 use 55002245
 Diesel : XJ, 1984-90 use 55002245

NOTE: 1. FOR WAGONEER USE 55008047.

Chrome - Right

6 Cyl : SJ, 1981-90 use J5764142
 8 Cyl : SJ, 1981-90 use J5764142

4 Cyl : XJ, 1984-90 use 55002244 1
 V6 Cyl : XJ, 1984-86 use 55002244 1
 I6 Cyl : XJ, 1987-90 use 55002244
 Diesel : XJ, 1984-90 use 55002244

NOTE: 1. FOR WAGONEER USE 55008046.

Grey - Left

6 Cyl : SJ, 1981-85 use J5752839
 8 Cyl : SJ, 1981-85 use J5752839

4 Cyl : XJ, 1984-90 use 55000683
 V6 Cyl : XJ, 1984-86 use 55000683
 I6 Cyl : XJ, 1987-90 use 55000683
 Diesel : XJ, 1984-90 use 55000683

Grey - Right

6 Cyl : SJ, 1981-85 use J5752838
 8 Cyl : SJ, 1981-85 use J5752838

4 Cyl : XJ, 1984-90 use 55000682 1
 V6 Cyl : XJ, 1984-86 use 55000682
 I6 Cyl : XJ, 1987-90 use 55000682
 Diesel : XJ, 1984-90 use 55000682

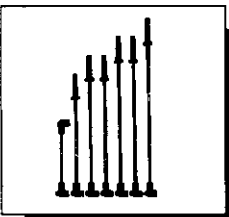

WIRE SET, Ignition

6 Cyl : SJ, 1979-87 use J8134371
 6 Cyl : SJ, 1988-90 use 83300088
 8 Cyl : SJ, 1979-89 use 83300090
 4 Cyl : XJ, 1984-90 use 83502400 1
 V6 Cyl : XJ, 1984-87 use 83500946
 I6 Cyl : XJ, 1986-87 use 83503408
 I6 Cyl : XJ, 1987-90 use 83300156 1

3.228

NOTE: 1. LESS COIL WIRE.

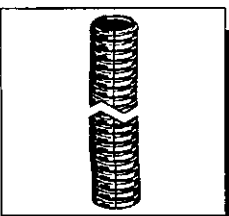

SHIELD, Ignition Wire

6 Cyl : SJ, 1987-90 use 33001774
 8 Cyl : SJ, 1987-90 use 33001774
 4 Cyl : XJ, 1984-90 use 33001774
 V6 Cyl : XJ, 1984-86 use 33001774
 I6 Cyl : XJ, 1987-90 use 33001774

3.228

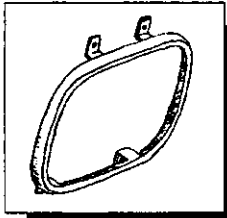

3.275

RING, Headlamp Retaining

6 Cyl : SJ, 1979-90 use J8129439
8 Cyl : SJ, 1979-90 use J8129439

4 Cyl : XJ, 1984-90 use 56001260 1
V6 Cyl : XJ, 1984-86 use 56001260 1
I6 Cyl : XJ, 1987-90 use 56001260 1
Diesel : XJ, 1984-90 use 56001260 1

NOTE: 1. FOR WAGONEER USE 36001060.

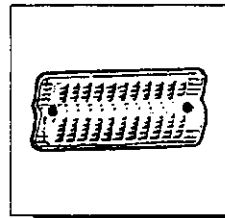

3.292

LENS, Parking & Front Directional - Right

6 Cyl : SJ, 1979-90 use J5460102
8 Cyl : SJ, 1979-90 use J5460102

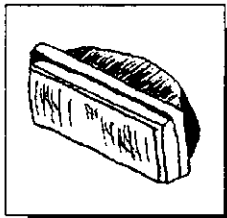

3.292

LAMP, Parking & Front Directional - Left

6 Cyl : SJ, 1979-90 use J5460107
8 Cyl : SJ, 1979-90 use J5460107

4 Cyl : XJ, 1984-90 use 56000099 1
V6 Cyl : XJ, 1984-86 use 56000099 1
I6 Cyl : XJ, 1987-90 use 56000099 1
Diesel : XJ, 1984-90 use 56000099 1

NOTE: 1. FOR WAGONEER (GREY) USE 56001531. FOR WAGONEER (CLEAR) USE 56003045.

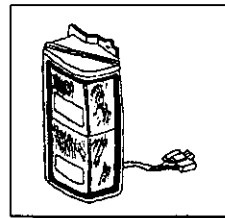

3.300

LAMP ASSY, Tail, Stop & Rear - Left

6 Cyl : SJ, 1979-82 use J5750335 1
6 Cyl : SJ, 1983-85 use J5761508 1
8 Cyl : SJ, 1979-82 use J5750335 1
8 Cyl : SJ, 1983-85 use J5761508 1

4 Cyl : XJ, 1984-87 use 83504317 2
V6 Cyl : XJ, 1984-86 use 83504317 2
I6 Cyl : XJ, 1987-90 use 83504317 2
Diesel : XJ, 1984-87 use 83504317 2

NOTE: 1. FOR J10 & J20 USE J0987831. FOR J10 & J20 - WITHOUT PICK-UP BOX USE J5456696. WITH SPORTSIDE USE J5751797.
2. FOR WAGONEER, RED, USE 83504117.

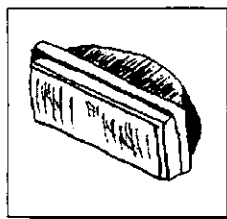

3.292

LAMP, Parking & Front Directional - Right

6 Cyl : SJ, 1979-90 use J5460106
8 Cyl : SJ, 1979-90 use J5460106

4 Cyl : XJ, 1984-90 use 56000098 1
V6 Cyl : XJ, 1984-86 use 56000098 1
I6 Cyl : XJ, 1987-90 use 56000098 1
Diesel : XJ, 1984-90 use 56000098 1

NOTE: 1. FOR WAGONEER (GREY) USE 56001530. FOR WAGONEER (CLEAR) USE 56003044.

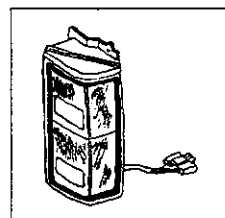

3.300

LAMP ASSY, Tail, Stop & Rear - Right

6 Cyl : SJ, 1979-82 use J5750336 1
6 Cyl : SJ, 1983-85 use J5761508 1
8 Cyl : SJ, 1979-82 use J5750336 1
8 Cyl : SJ, 1983-85 use J5761508 1

4 Cyl : XJ, 1984-87 use 83504316 2
V6 Cyl : XJ, 1984-86 use 83504316 2
I6 Cyl : XJ, 1987-90 use 83504316 2
Diesel : XJ, 1984-87 use 83504316 2

NOTE: 1. FOR J10 & J20 USE J0987832. FOR J10 & J20 - WITHOUT PICK-UP BOX USE J5456696. WITH SPORTSIDE USE J5751798.
2. FOR WAGONEER, RED, USE 83504116.

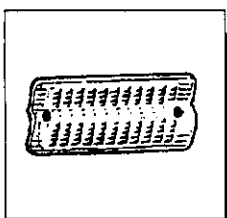

3.292

LENS, Parking & Front Directional - Left

6 Cyl : SJ, 1979-90 use J5460103
8 Cyl : SJ, 1979-90 use J5460103

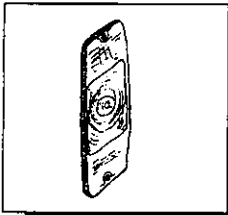

3.306

LENS, Tail & Stop Lamp
Wagoneer Only - **Left**

6 Cyl : SJ, 1979-83 use J5459551
6 Cyl : SJ, 1983-90 use J8134111
8 Cyl : SJ, 1979-83 use J5459551
8 Cyl : SJ, 1983-90 use J8134111

NOTE: 1. FOR INNER USE J5459550.

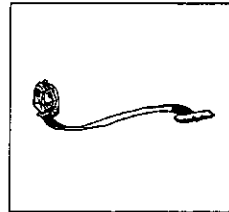

3.321

SWITCH, Directional

6 Cyl : SJ, 1979-85 use J3229970
6 Cyl : SJ, 1986-90 use 56002011
8 Cyl : SJ, 1979-85 use J3229970
8 Cyl : SJ, 1986-90 use 56002011

4 Cyl : XJ, 1984-90 use J3229970
V6 Cyl : XJ, 1984-86 use J3229970
I6 Cyl : XJ, 1987-90 use J3229970
Diesel : XJ, 1984-90 use J3229970

LENS, Tail & Stop Lamp
Wagoneer Only - **Right**

6 Cyl : SJ, 1979-83 use J5459552
6 Cyl : SJ, 1983-90 use J8134111
8 Cyl : SJ, 1979-83 use J5459552
8 Cyl : SJ, 1983-90 use J8134111

NOTE: 1. FOR INNER USE J5459550.

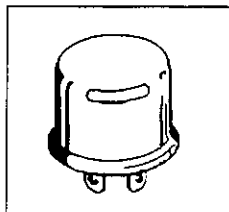

3.330

FLASHER, Directional Signal

STANDARD (224) use J3837161
HEAVY (323) use J3212067
3 BLADES (550) use 56000903
2 BLADES (552) use J5452266

LENS, Tail & Stop Lamp
Truck Only - **Left**

6 Cyl : SJ, 1979-88 use J0988111
8 Cyl : SJ, 1979-88 use J0988111

NOTE: 1. WITHOUT PICK-UP BOX USE J8122928.
WITH SPORTSIDE USE J5457724.

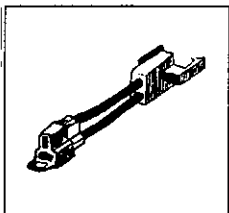

3.333

SWITCH, Stop Lamp

6 Cyl : SJ, 1979-90 use J5352620
8 Cyl : SJ, 1979-90 use J5352620

4 Cyl : XJ, 1984-90 use J3225787
V6 Cyl : XJ, 1984-86 use J3225787
I6 Cyl : XJ, 1987-90 use J3225787
Diesel : XJ, 1984-90 use J3225787

NOTE: 1. WITHOUT CRUISE CONTROL USE
J3213938.

LENS, Tail & Stop Lamp
Truck Only - **Right**

6 Cyl : SJ, 1979-88 use J0988112
8 Cyl : SJ, 1979-88 use J0988112

NOTE: 1. WITHOUT PICK-UP BOX USE J8122928.
WITH SPORTSIDE USE J5457724.

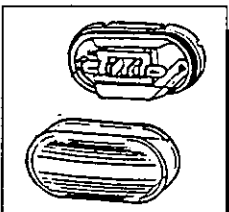

3.335

LAMP, License Plate

6 Cyl : SJ, 1979-90 use J3670544
8 Cyl : SJ, 1979-90 use J3670544

4 Cyl : XJ, 1984-90 use 56000674
V6 Cyl : XJ, 1984-86 use 56000674
I6 Cyl : XJ, 1987-90 use 56000674
Diesel : XJ, 1984-90 use 56000674

NOTE: 1. USED WITH SWING-AWAY SPARE TIRE
CARRIER.

LENS, Tail & Stop Lamp
Cherokee Only - **Left & Right**

6 Cyl : SJ, 1979-80 use J8124341
6 Cyl : SJ, 1981-90 use J8134111
8 Cyl : SJ, 1979-80 use J8124341
8 Cyl : SJ, 1981-90 use J8134111

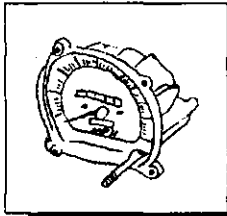

3.550

SPEEDOMETER, Miles

6 Cyl : SJ, 1979-81 use J8131749
 6 Cyl : SJ, 1982-84 use J8134124
 6 Cyl : SJ, 1985 use 83501427
 6 Cyl : SJ, 1986-90 use 83502521
 8 Cyl : SJ, 1979-81 use J8131749
 8 Cyl : SJ, 1982-84 use J8134124
 8 Cyl : SJ, 1985 use 83501427
 8 Cyl : SJ, 1986-90 use 83502521

4 Cyl : XJ, 1984-87 use 83500294 1
 4 Cyl : XJ, 1987-90 use 83504224
 V6 Cyl : XJ, 1984-86 use 83500294 1
 I6 Cyl : XJ, 1987-90 use 83504224
 Diesel : XJ, 1984-87 use 83500294 1
 Diesel : XJ, 1987-90 use 83504224

NOTE:

1. WITH PHILLIPS HEAD SCREWS SHOWING, USE 83504224.

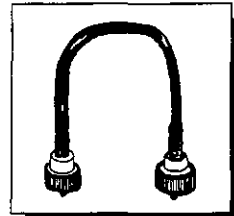

3.570

CABLE, Speedometer - SJ Models

4 Speed Manual

6 Cylinder, 1979 use J5351777
 6 Cylinder, 1980 use J5752283
 6 Cylinder, 1981-90 use J5752281 1
 8 Cylinder, 1979 use J5351777
 8 Cylinder, 1980-85 use J5752283
 8 Cylinder, 1981-90 use J5752281 1

NOTE: 1. WITH J20 USE J5752280.

5 Speed Manual

6 Cylinder, 1982-90 use J5752282
 8 Cylinder, 1982-90 use J5752282

Automatic Trans

6 Cylinder, 1979 use J5353092
 6 Cylinder, 1980-82 use J5752282 1
 6 Cylinder, 1980-82 use J5752280 2
 6 Cylinder, 1983-90 use J5752280 3
 6 Cylinder, 1983-90 use J5752282 4

8 Cylinder, 1979 use J5353092
 8 Cylinder, 1980-82 use J5752281 1
 8 Cylinder, 1980-82 use J5752282 2
 8 Cylinder, 1983-90 use J5752281 4
 8 Cylinder, 1983-90 use J5752282 3

NOTE: 1. WITH PART TIME TRANSFER CASE.
 2. WITH FULL TIME TRANSFER CASE.
 3. WITH MODEL 229 TRANSFER CASE.
 4. WITH MODEL 208 TRANSFER CASE.

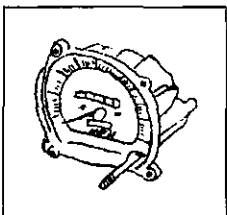

3.550

SPEEDOMETER, Kilos

6 Cyl : SJ, 1979-81 use J8130355
 6 Cyl : SJ, 1982-84 use J8134125
 6 Cyl : SJ, 1985 use 83501438
 6 Cyl : SJ, 1986-90 use 83502530
 8 Cyl : SJ, 1979-81 use J8130355
 8 Cyl : SJ, 1982-84 use J8134125
 8 Cyl : SJ, 1985 use 83501438
 8 Cyl : SJ, 1986-90 use 83502530

4 Cyl : XJ, 1984-87 use 83500297 1
 4 Cyl : XJ, 1987-90 use 83504225
 V6 Cyl : XJ, 1984-86 use 83500297 1
 I6 Cyl : XJ, 1987-90 use 83504225
 Diesel : XJ, 1984-86 use 83500297 1
 Diesel : XJ, 1987-90 use 83504225

NOTE:

1. WITH PHILLIPS HEAD SCREWS SHOWING USE 83504225.

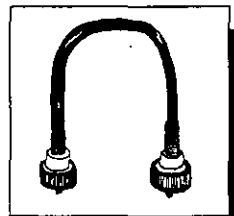

3.570

CABLE, Speedometer - XJ Models

4WD without Speed Control

4, V6, I6 :1984-90 use 53004954 1
 Diesel :1984-90 use 53004952

NOTE: 1. UP TO 1987, IF SPEEDOMETER FACE HAS 2 SLOTTED HEAD SCREWS USE CABLE 53004895.

4WD with Speed Control

Upper Cable:1984-90 use 53004955 1
 Lower Cable:1984-86 use 53003899
 Lower Cable:1987-90 use 53003894

NOTE: 1. UP TO 1987, IF SPEEDOMETER FACE HAS 2 SLOTTED HEAD SCREWS USE CABLE 53003073.

3.333

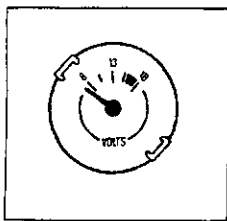

VOLTMETER

4 Cyl : XJ, 1984-87 use 83500318 1
 4 Cyl : XJ, 1988-90 use 83505413 2
 V6 Cyl : XJ, 1984-86 use 83500318 1
 I6 Cyl : XJ, 1987 use 83500318 1
 I6 Cyl : XJ, 1988-90 use 83505413 2

3.600

NOTE: 1. 1986-87, FOR SPEEDOMETER FACE WITH 2 PHILLIPS HEAD SCREWS USE 83504247.
 2. WITH TACHOMETER USE 83504465.

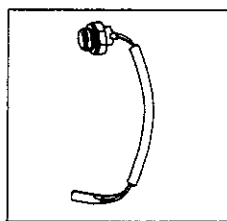

SENSOR, Coolant

4 Cyl : XJ, 1986-90 use 33002383 1
 I6 Cyl : XJ, 1987-90 use 33002383

NOTE: 1. WITH FUEL INJECTION.

3.605

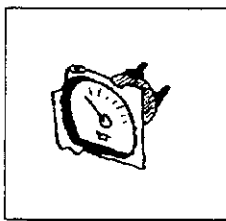

GAUGE, Oil Pressure

6 Cyl : SJ, 1979-84 use J8126929
 6 Cyl : SJ, 1985 use 83501435
 6 Cyl : SJ, 1986-90 use 83502528
 8 Cyl : SJ, 1979-84 use J8126929
 8 Cyl : SJ, 1985 use 83501435
 8 Cyl : SJ, 1986-90 use 83502528

3.605

4 Cyl : XJ, 1984-87 use 83500307
 4 Cyl : XJ, 1987-90 use 83504243 1
 V6 Cyl : XJ, 1984-86 use 83500307
 I6 Cyl : XJ, 1987 use 83500307
 I6 Cyl : XJ, 1987-90 use 83504243 1
 Diesel : XJ, 1984-87 use 83501565
 Diesel : XJ, 1988-90 use 83504509

NOTE: 1. USED W/ SPEEDOMETER W/ 2 PHILLIPS HEAD SCREWS. WITH TACHOMETER USE 83504463.

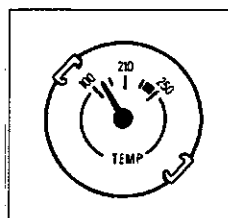

GAUGE, Water Temperature

6 Cyl : SJ, 1979-84 use J8126928
 6 Cyl : SJ, 1985 use 83501428
 6 Cyl : SJ, 1986-90 use 83502527
 8 Cyl : SJ, 1979-84 use J8126928
 8 Cyl : SJ, 1985 use 83501428
 8 Cyl : SJ, 1986-90 use 83502527

3.610

4 Cyl : XJ, 1984-87 use 83500311
 4 Cyl : XJ, 1988-90 use 83504239 1
 V6 Cyl : XJ, 1984-86 use 83500311
 I6 Cyl : XJ, 1987 use 83500311
 I6 Cyl : XJ, 1988-90 use 83504239 1
 Diesel : XJ, 1984-87 use 83501560
 Diesel : XJ, 1988-90 use 83504507

NOTE: 1. USED W/ SPEEDOMETER W/ 2 PHILLIPS HEAD SCREWS. WITH TACHOMETER USE 83504461.

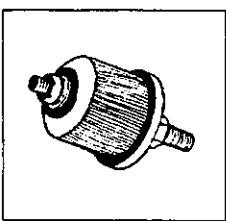

SENDING UNIT, Oil Pressure

6 Cyl : SJ, 1979-85 use J3212004
 6 Cyl : SJ, 1986-90 use 53005218
 8 Cyl : SJ, 1979-85 use J3212004
 8 Cyl : SJ, 1986-90 use 53005218

3.605

4 Cyl : XJ, 1984-90 use 53005218
 V6 Cyl : XJ, 1984-86 use 83500307
 I6 Cyl : XJ, 1987-90 use 53005218
 Diesel : XJ, 1984-87 use 33002472
 Diesel : XJ, 1988-90 use 53005218

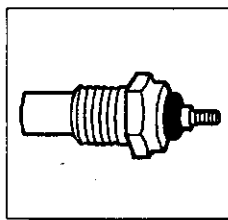

SENDING UNIT, Water Temperature

6 Cyl : SJ, 1979-85 use J3177594
 6 Cyl : SJ, 1986-90 use 53004981 1
 8 Cyl : SJ, 1981-85 use J3177594
 8 Cyl : SJ, 1986-90 use 53004981 1

3.610

4 Cyl : XJ, 1984-90 use 53004981 1
 V6 Cyl : XJ, 1984-86 use 53004981 1
 I6 Cyl : XJ, 1987-90 use 53004981 1
 Diesel : XJ, 1984-90 use 53004981 1

NOTE: 1. WITH THREADED TERMINAL ON SWITCH USE J3230408.

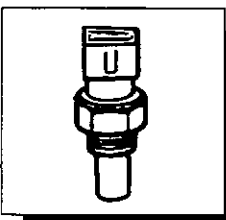

SENSOR, Air Temp (at Intake Manifold)

4 Cyl : XJ, 1986-90 use 33002382 1
 I6 Cyl : XJ, 1987-90 use 33002382

NOTE: 1. WITH FUEL INJECTION.

3.605

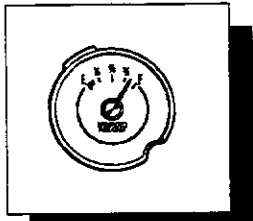

3.615

GAUGE, Fuel (In Instrument Cluster)

6 Cyl : SJ, 1979-84 use J8126927
 6 Cyl : SJ, 1985 use 83501434
 6 Cyl : SJ, 1986-90 use 83502526
 8 Cyl : SJ, 1979-84 use J8126927
 8 Cyl : SJ, 1985 use 83501434
 8 Cyl : SJ, 1986-90 use 83502526

4 Cyl : XJ, 1984-87 use 83500298 ¹
 4 Cyl : XJ, 1987-90 use 83504234 ²
 V6 Cyl : XJ, 1984-86 use 83500298 ¹
 I6 Cyl : XJ, 1987 use 83500298 ¹
 I6 Cyl : XJ, 1987-90 use 83504234 ²
 Diesel : XJ, 1984-87 use 83501563

NOTE: 1. FOR 1986-87, WITHOUT FUEL INJECTION USE 83503466.
 2. USED W/ SPEEDOMETER FACE WITH 2 PHILLIPS HEAD SCREWS. WITH TACHOMETER USE 83504459.

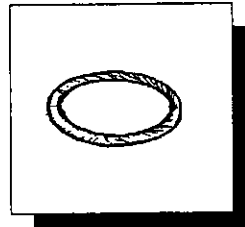

3.615

GASKET, Fuel Gauge to Tank (O-Ring)

6 Cyl : SJ, 1979-90 use J0941521
 8 Cyl : SJ, 1979-90 use J0941521

4 Cyl : XJ, 1984-90 use 53000575
 V6 Cyl : XJ, 1984-86 use 53000575
 I6 Cyl : XJ, 1987-90 use 53000575
 Diesel : XJ, 1984-90 use 53000575

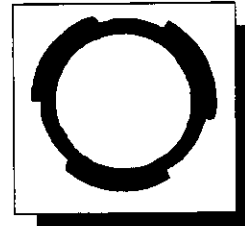

3.615

LOCK, to Fuel Tank

6 Cyl : SJ, 1979 use J0938458
 6 Cyl : SJ, 1980-90 use J5370014
 8 Cyl : SJ, 1979 use J0938458
 8 Cyl : SJ, 1980-90 use J5370014

4 Cyl : XJ, 1984-90 use 53000584
 V6 Cyl : XJ, 1984-86 use 53000584
 I6 Cyl : XJ, 1987-90 use 53000584
 Diesel : XJ, 1984-90 use 53000584



3.615

GAUGE, Fuel (In Gas Tank)

SJ Vehicles

6 Cyl : SJ, 1979 use J5358560 ¹
 6 Cyl : SJ, 1980-85 use J5363490 ²
 6 Cyl : SJ, 1986 use 53003099 ³
 8 Cyl : SJ, 1979 use J5358560 ¹
 8 Cyl : SJ, 1980-85 use J5363490 ²
 8 Cyl : SJ, 1986 use 53003099 ³

NOTE: 1. FOR J10 & J20 USE J5357677.
 2. FOR J10 & J20 USE J5363977.
 3. FOR J10 & J20 USE 53003201.

XJ Vehicles

with Carbureted Engine

4 Cyl : XJ, 1984-90 use 52003647

XJ Vehicles

with Fuel Injection & 13.5 Gallon Tank

4 Cyl : XJ, 1984-90 use 83504480
 I6 Cyl : XJ, 1987-90 use 83504488

XJ Vehicles

with Fuel Injection & 20.2 Gallon Tank

4 Cyl : XJ, 1984-90 use 83504484
 I6 Cyl : XJ, 1987-90 use 83504487
 Diesel : XJ, 1984-90 use 83506285

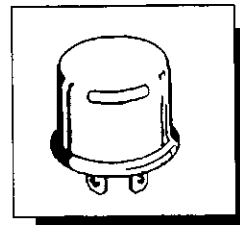

3.690

FLASHER, Hazard Warning

6 Cyl : SJ, 1979-90 use J5452266
 8 Cyl : SJ, 1979-90 use J5452266

4 Cyl : XJ, 1984-90 use J5452266
 V6 Cyl : XJ, 1984-86 use J5452266
 I6 Cyl : XJ, 1987-90 use J5452266
 Diesel : XJ, 1984-90 use J5452266

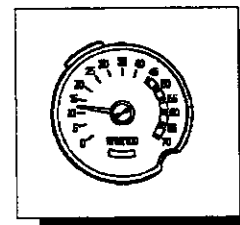

3.700

TACHOMETER

4 Cyl : XJ, 1984-87 use 83500308 ¹
 4 Cyl : XJ, 1988-90 use 83504504
 V6 Cyl : XJ, 1984-86 use 83500309 ¹
 I6 Cyl : XJ, 1987 use 83500309 ¹
 I6 Cyl : XJ, 1988-90 use 83504458
 Diesel : XJ, 1984-87 use 83501567 ¹
 Diesel : XJ, 1988-90 use 83504504

NOTE: 1. FOR 1986-87, WITH SPEEDOMETER FACE WITH 2 PHILLIPS HEAD SCREWS USE:
 FOR 4 CYL : 83504229
 FOR 6 CYL : 83504228
 FOR DIESEL : 83504230

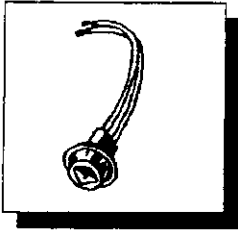

CABLE, Front Fender Side Lamp

6 Cyl : SJ, 1979-90 use J0989428
 8 Cyl : SJ, 1979-90 use J0989428

3.720

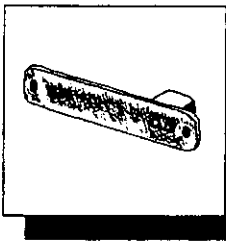

LAMP, Front Side Marker (Amber)

6 Cyl : SJ, 1979-90 use J0994020
 8 Cyl : SJ, 1979-90 use J0994020

4 Cyl : XJ, 1984-90 use 56000111 1
 V6 Cyl : XJ, 1984-86 use 56000111 1
 I6 Cyl : XJ, 1984-90 use 56000111 1
 Diesel : XJ, 1984-90 use 56000111 1

3.720

NOTE: 1. THIS IS FOR LEFT SIDE. FOR RIGHT SIDE USE 56000110.

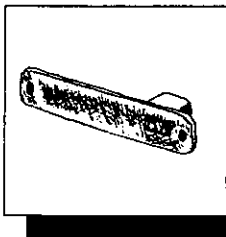

LAMP, Rear Side Marker (Red)

6 Cyl : SJ, 1979-90 use J0994021
 8 Cyl : SJ, 1979-90 use J0994021

3.740

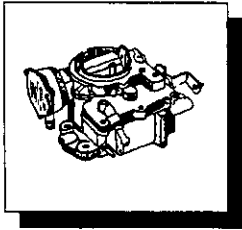

CARBURETOR,
with Automatic Transmission

4.001

TAG NO.

- 6 Cyl : SJ, 1979 use J3233977 BBD-8195S
- 6 Cyl : SJ, 1980 use J3235767 BBD-8255S
- 6 Cyl : SJ, 1981 use J3238404 BBD-8312S
- 6 Cyl : SJ, 1982 use J3241127 BBD-8340S
- 6 Cyl : SJ, 1983 use 33000482 BBD-8362S
- 6 Cyl : SJ, 1984-90 use 33001707 BBD-8383S
- 8 Cyl : SJ, 1979 use J3233983 9RHA2
- 8 Cyl : SJ, 1980 use J3235796 0RHA2
- 8 Cyl : SJ, 1981-82 use J3238411 1RHA2
- 8 Cyl : SJ, 1983 use J3241630 2RHA2A
- 8 Cyl : SJ, 1984 use 33001726 4RHA2
- 8 Cyl : SJ, 1985-90 use 53002537 5RHA2

- 4 Cyl : XJ, 1984-85 use 33002114 7701
- 4 Cyl : XJ, 1986-87 use 53002638 7705
- V6 Cyl : XJ, 1984-85 use 33002114 7701
- V6 Cyl : XJ, 1986 use 53002230 5380

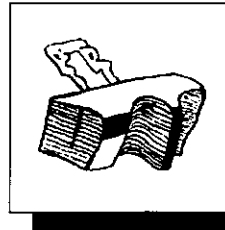

FLOAT, Carburetor

4.001

- 6 Cyl : SJ, 1979-90 use J8127325
- 8 Cyl : SJ, 1979-85 use J4488178
- 8 Cyl : SJ, 1986-90 use 83500930

- 4 Cyl : XJ, 1984-90 use 83500454
- V6 Cyl : XJ, 1984-86 use 83501023

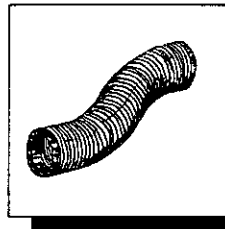

TUBE, Air Cleaner Duct (Hot Air)

4.015

- 6 Cyl : SJ, 1979-85 use J3229841
- 8 Cyl : SJ, 1979-85 use J3229841

- 4 Cyl : XJ, 1984-90 use 33003391 ¹
- V6 Cyl : XJ, 1984-86 use 33001609
- I6 Cyl : XJ, 1987-90 use 53004839

NOTE: 1. WITH FUEL INJECTION USE 53002877.

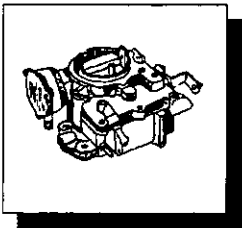

CARBURETOR,
with Manual Transmission

4.001

TAG NO.

- 6 Cyl : SJ, 1979 use J3233977 BBD-8195S
- 6 Cyl : SJ, 1980 use J3235767 BBD-8255S
- 6 Cyl : SJ, 1981-82 use J3241128 BBD-8341S
- 6 Cyl : SJ, 1983 use 33000483 BBD-8367S
- 6 Cyl : SJ, 1984-90 use 33001708 BBD-8384S
- 8 Cyl : SJ, 1979 use J3233982 9RHM2
- 8 Cyl : SJ, 1980 use J3235797 0RHM2
- 8 Cyl : SJ, 1981-83 use J3238412 1RHM2
- 8 Cyl : SJ, 1984 use 33001726 4RHA2
- 8 Cyl : SJ, 1985-90 use 53002537 5RHA2

- 4 Cyl : XJ, 1984-85 use 33002115 7700
- 4 Cyl : XJ, 1986-90 use 53002641 7708
- V6 Cyl : XJ, 1984-85 use 33002115 7700
- V6 Cyl : XJ, 1986-86 use 53002229 5381

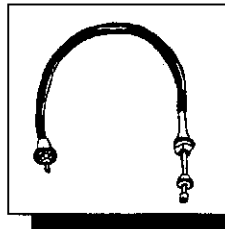

CABLE, Accelerator

4.057

- 6 Cyl : SJ, 1979-80 use J5357703
- 6 Cyl : SJ, 1981-85 use J5362800
- 6 Cyl : SJ, 1986-90 use 53005203
- 8 Cyl : SJ, 1979-85 use J5357962
- 8 Cyl : SJ, 1986-90 use 53005205

- 4 Cyl : XJ, 1984-88 use 53001572 ¹
- 4 Cyl : XJ, 1988-90 use 53005246 ²
- V6 Cyl : XJ, 1984-86 use 53000038
- I6 Cyl : XJ, 1987-90 use 53005245
- Diesel : XJ, 1984-86 use 53001795
- Diesel : XJ, 1987-88 use 53005204
- Diesel : XJ, 1988-90 use 53005247

NOTE: 1. WITH FUEL INJECTION FOR 1986 USE 53002422. FOR 1987-88 USE 53003652.

2. FOR 1988-90, WITH FUEL INJECTION USE 53005244.

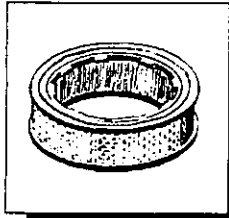

4.088

ELEMENT, Air Cleaner

6 Cyl : SJ, 1979-90 use J8991386
8 Cyl : SJ, 1979-90 use J8992661

4 Cyl : XJ, 1984-90 use 83500999 ¹
V6 Cyl : XJ, 1984-86 use J8991386
I6 Cyl : XJ, 1987-90 use 53004383
Diesel : XJ, 1984-90 use 83501843

NOTE: 1. WITH FUEL INJECTION FOR 1986 USE 53002184. FOR 1987- 90 USE 53004383.

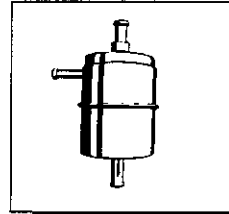

4.110

FILTER KIT, Fuel Pump Line

6 Cyl : SJ, 1979-90 use J8129383
8 Cyl : SJ, 1979-90 use J8129383

4 Cyl : XJ, 1984-90 use 83500998 ¹
4 Cyl : XJ, 1986-90 use 33000076 ²
V6 Cyl : XJ, 1984-86 use 33000076
I6 Cyl : XJ, 1987-90 use 33000076

NOTE: 1. WITH CARBURETED ENGINE.
2. WITH FUEL INJECTION.

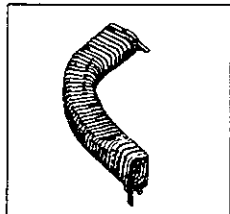

4.092

TUBE, Cold Air Induction

6 Cyl : SJ, 1979-90 use J5357886
8 Cyl : SJ, 1979-90 use J5358444

W/ CARBURETED ENGINE

4 Cyl : XJ, 1984-87 use 33002113
4 Cyl : XJ, 1988-90 use 54005144
V6 Cyl : XJ, 1984-86 use 33000260

W/ FUEL INJECTION

4 Cyl : XJ, 1986 use 53002180
4 Cyl : XJ, 1987-90 use 53002876
I6 Cyl : XJ, 1987-88 use 53002736
I6 Cyl : XJ, 1989-90 use 53006196

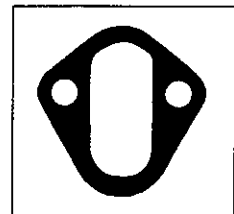

4.116

**GASKET, Fuel Pump
(with Carbureted Engine)**

6 Cyl : SJ, 1979-88 use J3174685
8 Cyl : SJ, 1979-88 use J3174685

4 Cyl : XJ, 1984-88 use J3174685
V6 Cyl : XJ, 1984-86 use 83500874
I6 Cyl : XJ, 1987-88 use J3174685
Diesel : XJ, 1984-88 use J3174685

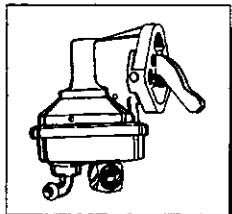

4.110

PUMP, Fuel

6 Cyl : SJ, 1979-80 use J3228191
6 Cyl : SJ, 1981-85 use J3240172
6 Cyl : SJ, 1986-90 use J3228191
8 Cyl : SJ, 1979-85 use J3227884
8 Cyl : SJ, 1986-90 use J3228195

W/ CARBURETED ENGINE

4 Cyl : XJ, 1984-90 use 33002652
V6 Cyl : XJ, 1984-85 use 83500873
V6 Cyl : XJ, 1986 use 83502715
Diesel : XJ, 1984-90 use T0726944

W/ FUEL INJECTION

4 Cyl : XJ, 1986-90 use 83502751
I6 Cyl : XJ, 1987-90 use 83504634

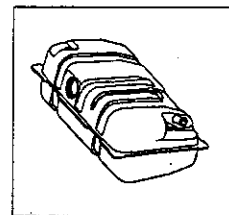

4.130

FUEL TANK ASSY

6 Cyl : SJ, 1979 use J8128589 ¹
6 Cyl : SJ, 1980-88 use J5362496 ²
8 Cyl : SJ, 1979 use J8128589 ¹
8 Cyl : SJ, 1980-88 use J5362496 ²

W/ CARBURETED ENGINE

ALL XJ'S, 1984-90 use 83500267
FOR MJ'S, 1984-90 use 83502635 ³

W/ FUEL INJECTION

ALL XJ'S, 1984-90 use 83500633
FOR MJ'S, 1984-90 use 83502632 ³

WITH DIESEL

ALL XJ'S, 1984-90 use 83300267
FOR MJ'S, 1984-90 use 83502535 ³

NOTE: 1. FOR J10 & J20 USE J8128590.
2. FOR J10 & J20 USE J5362499.
3. MJ'S WITH 6' BOX USE 83503398.

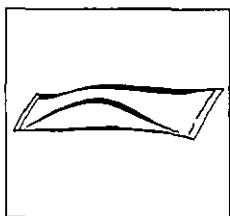

4.134

FILTER, Fuel Tank

6 Cyl : SJ, 1979 use J5357421
 6 Cyl : SJ, 1980-88 use J5361389
 8 Cyl : SJ, 1979 use J5357421
 8 Cyl : SJ, 1980-88 use J5361389

W/ CARBURETED ENGINE

4 Cyl : XJ, 1984-90 use 53001248
 V6 Cyl : XJ, 1984-86 use 53001248

W/ FUEL INJECTION

4 Cyl : XJ, 1986-90 use 33000184
 V6 Cyl : XJ, 1987-90 use 33000184

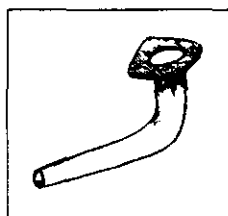

4.178

PIPE, Exhaust

with 5 Speed

4 Cyl : XJ, 1984-85 use 53000067
 4 Cyl : XJ, 1986 use 53001516
 4 Cyl : XJ, 1987-90 use 52003008
 V6 Cyl : XJ, 1984-85 use 53001388
 V6 Cyl : XJ, 1986 use 53001392
 I6 Cyl : XJ, 1987-90 use 52002989
 Diesel : XJ, 1984-86 use 52001819
 Diesel : XJ, 1987-90 use 52003011

with 4 speed

6 Cyl : SJ, 1979 use J5358913 ¹
 6 Cyl : SJ, 1980 use J5359919
 6 Cyl : SJ, 1981 use J5362470
 6 Cyl : SJ, 1982 use J5362167
 6 Cyl : SJ, 1983-90 use J5364317
 8 Cyl : SJ, 1979 use J5359109 ²
 8 Cyl : SJ, 1980 use J5360057
 8 Cyl : SJ, 1981-85 use J5362534 ³
 8 Cyl : SJ, 1986-90 use J5362536

NOTE: 1. FOR J10 & J20 USE J5358915.
 FOR 3 SPEED USE J5358914.
 FOR 3 SPEED, J10 & J20, USE J5358916.
 2. FOR J10 & J20 USE J5359115.
 3. FOR J20 USE J5362535.

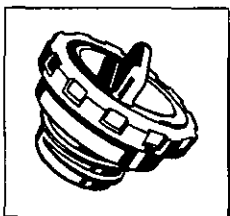

4.138

CAP, Non-Locking Gas Tank Filler

6 Cyl : SJ, 1979-90 use 52003766 ¹
 8 Cyl : SJ, 1979-90 use 52003766 ¹

4 Cyl : XJ, 1984-87 use 52003774 ¹
 4 Cyl : XJ, 1988-90 use 52003770
 4 Cyl : XJ, 1988-90 use 52003770
 V6 Cyl : XJ, 1984-86 use 52003774 ¹
 I6 Cyl : XJ, 1987 use 52003774 ¹
 I6 Cyl : XJ, 1988-90 use 52003770
 Diesel : XJ, 1984-87 use 52003774 ¹
 Diesel : XJ, 1988-90 use 52003770

NOTE:
 1. FOR LOCKING GAS CAP USE 82400041.

with Automatic Transmission

6 Cyl : SJ, 1979 use J5358913
 6 Cyl : SJ, 1980 use J5359920
 6 Cyl : SJ, 1981 use J5362471
 6 Cyl : SJ, 1982 use J5362168
 6 Cyl : SJ, 1983-90 use J5364317
 8 Cyl : SJ, 1979 use J5359109 ¹
 8 Cyl : SJ, 1980 use J5361020
 8 Cyl : SJ, 1981-90 use J5362536

4 Cyl : XJ, 1984-85 use 53000067
 4 Cyl : XJ, 1986 use 53001516
 4 Cyl : XJ, 1987-90 use 52003008
 V6 Cyl : XJ, 1984-85 use 53001388
 V6 Cyl : XJ, 1986 use 53001392
 I6 Cyl : XJ, 1987-90 use 52002989

NOTE: 1. FOR J10 & J20 USE J5359118.

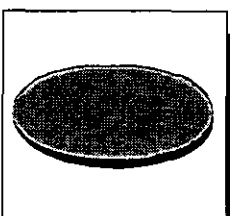

4.144

FILTER, Fuel Vapor Storage Canister

6 Cyl : SJ, 1979-90 use J3227279
 8 Cyl : SJ, 1979-90 use J3227279



4.186

SEAL, Exhaust Pipe to Manifold

6 Cyl : SJ, 1979 use J3223546
 8 Cyl : SJ, 1979-90 use J3223547

 4 Cyl : XJ, 1984-90 use 52003025
 V6 Cyl : XJ, 1984-86 use 53000692
 I6 Cyl : XJ, 1987-90 use 52003025

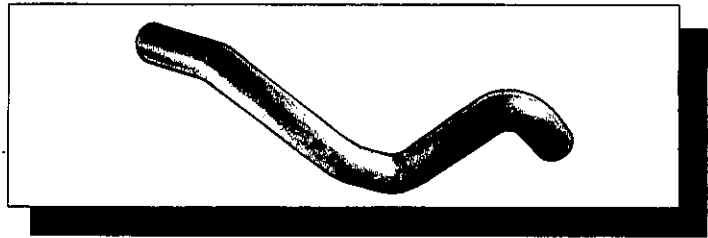

4.227 TAILPIPES

J-SERIES

6 Cyl	Wag-Cher	1979	J5358923
6 Cyl	Wag-Cher	1980	J5360087
6 Cyl	Wag-Cher	1981	J5361873
6 Cyl	Wag-Cher	1982-90	J5363115
6 Cyl	J10	1979	J5358960
6 Cyl	J10	1980	J5361952
6 Cyl	J10	1981-90	J5361952 ¹
6 Cyl	J20	1979	J5358987
6 Cyl	J20	1980	J5361954

8 Cyl	Wag-Cher	1979	J5368640
8 Cyl	Wag-Cher	1980-83	J5360080
8 Cyl	Wag-Cher	1984-90	J5364858
8 Cyl	J10	1979	J5358534
8 Cyl	J10	1980-82	J5361989 ³
8 Cyl	J10	1983-90	J5363117 ⁴
8 Cyl	J20	1979	J5356458
8 Cyl	J20	1980	J5361985

XJ

4 Cyl	1984-86	83501931
4 Cyl	1987-90	52003985 ²
V6 Cyl	1984-86	83501931
I6 Cyl	1987-90	52003985 ²

NOTE: 1. FOR J10 WITH 131" WHEELBASE.
 2. MUFFLER AND TAILPIPE ASSEMBLY.
 3. FOR J10 WITH 131" WHEELBASE USE J5361985.
 4. FOR J10 WITH 131" WHEELBASE USE J5363117.

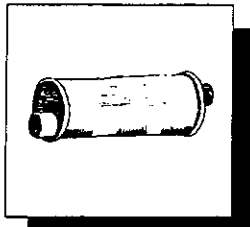

4.210

MUFFLER

6 Cyl : SJ, 1979 use J5358799
 6 Cyl : SJ, 1980 use J5361132¹
 6 Cyl : SJ, 1981 use J5362494
 6 Cyl : SJ, 1982-85 use J5362284²
 6 Cyl : SJ, 1986-87 use J5362489
 8 Cyl : SJ, 1979 use J5359456
 8 Cyl : SJ, 1980 use J5360106³
 8 Cyl : SJ, 1981-90 use J5362540⁴

4 Cyl : XJ, 1984-85 use 83500482
 4 Cyl : XJ, 1986 use 83502646
 4 Cyl : XJ, 1987-90 use 52003985⁵
 V6 Cyl : XJ, 1984-85 use 83500483
 V6 Cyl : XJ, 1986 use 83502648
 I6 Cyl : XJ, 1987-90 use 52003985⁵
 Diesel : XJ, 1984-90 use 83501930

NOTE: 1. FOR J10 & J20 USE J5360904.
 2. FOR J10 & J20 USE J5362489.
 3. FOR J10 & J20 USE J5361254.
 4. FOR J10 & J20 FOR 1981-85 USE J5361821. FOR 1986-89 USE J5361254.
 5. MUFFLER AND TAILPIPE ASSY.

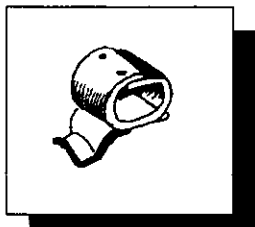

4.219

INSULATOR, Muffler and Tail Support (Front)

6 Cyl : SJ, 1981-90 use J5363088
 8 Cyl : SJ, 1981-90 use J5363088

4 Cyl : XJ, 1984-90 use 53000101
 V6 Cyl : XJ, 1984-86 use 53000101
 I6 Cyl : XJ, 1987-90 use 53000101
 Diesel : XJ, 1984-90 use 53000101

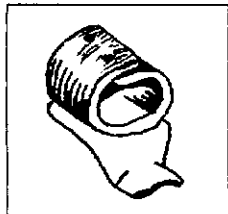

4.234

INSULATOR, Tailpipe Support
(Rear)

6 Cyl : SJ, 1979-80 use J5354074
 6 Cyl : SJ, 1981-90 use J5363087
 8 Cyl : SJ, 1979-80 use J5357043 ¹
 8 Cyl : SJ, 1981-90 use J5363087

4 Cyl : XJ, 1984-86 use J5363088
 4 Cyl : XJ, 1987-90 use 52002794 ²
 V6 Cyl : XJ, 1984-86 use J5363088
 I6 Cyl : XJ, 1987-90 use 52002794 ²
 Diesel : XJ, 1984-87 use J5363088
 Diesel : XJ, 1988-90 use 52002794 ²

NOTE: 1. FOR J10 & J20 USE J5354074.
 2. FOR COMANCHE - WITH 6 FT. BOX USE
 52003019. WITH 7 FT. BOX USE 52003015.

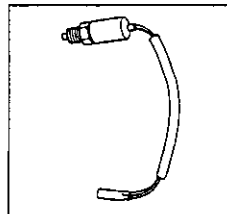

4.710

OXYGEN SENSOR

6 Cyl : SJ, 1984-86 use 33002455
 6 Cyl : SJ, 1987-90 use 33004243

4 Cyl : XJ, 1984-85 use 33002455
 4 Cyl : XJ, 1986-90 use 53002106
 V6 Cyl : XJ, 1984-86 use 53000886
 I6 Cyl : XJ, 1987-90 use 53004245

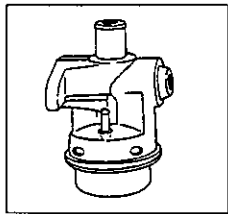

4.558

VALVE, Exhaust Emission Back-Fire
(Diverter)

6 Cyl : SJ, 1979-80 use J3223634
 8 Cyl : SJ, 1979-90 use J3230822

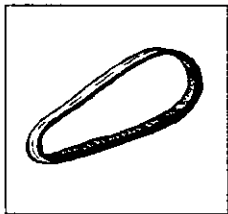

4.612

BELT, Crankshaft to Exhaust Emission
Pump

6 Cyl : SJ, 1981-90 use J3226936 ²
 8 Cyl : SJ, 1981-90 use J3227692 ¹

NOTE: 1. FOR 1979-80, WITH 53-1/4"
 CIRCUMFERENCE USE J3229862.
 2. FROM POWER STEERING PUMP.

REPAIR KIT, Carburetor

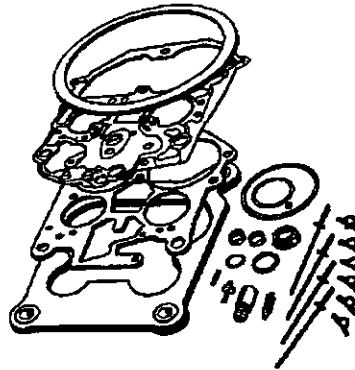

<u>TAG #</u>	<u>YEAR</u>	<u>REPAIR KIT PART #</u>	<u>TAG #</u>	<u>YEAR</u>	<u>REPAIR KIT PART #</u>
BBD-8195S	1979	J8127315	0RA2	1981	J8128346
9RHA2	1979	J8133820	1RHA2	1981	J8133822
9RHA2J	1979	J8133820	1RHM2	1981-82	J8133822
9RHM2	1979	J8133820	2RHA2A	1982-85	J8133822
BBD-8255S	1980	J8127315	1RHM2	1981-82	J8133822
0RHA2	1980	J8133820	1RHA2	1982-83	J8133822
0RHM2	1980	J8133820	4RHA2	1984	J8133822
BBD-8255	1981	J8127315	5RHA2	1985/	83502174
BBD-8284	1981	J8132617			
BBD-8306	1981	J8133460			
BBD-8307	1981	J8133460			
BBD-8312	1981	J8132617			
BBD-8340	1982	J8134232			
BBD-8341	1982	J8134232			
BBD-8355	1982-85	J8134232			
BBD-8360	1983	J8134232			
BBD-8362	1983	J8134232			
BBD-8364	1983/	J8134232			
BBD-8366	1983/	J8134232			
BBD-8367	1983	J8134232			
BBD-8372	1982-84	J8134232			
BBD-8383	1984/	J8134232			
BBD-8384	1984/	J8134232			
			<u>XJ SERIES</u>		
			4580	1984	83501011
			4581	1984	83501011
			4582	1984	83501011
			4583	1984	83501011
			4584	1984	83500924
			5006	1985	83501938
			5380	1985-86	83501011
			5381	1985-86	83501011
			5382	1985-86	83501011
			5383	1985-86	83501011
			5388	1985-86	83501938
			6081	1986	83501938

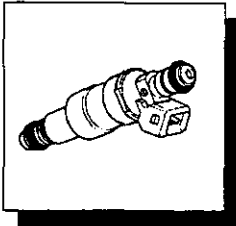

4.840

INJECTOR, Fuel

4 Cyl : XJ, 1986-87 use 83502578
 4 Cyl : XJ, 1988-90 use 83504851
 16 Cyl : XJ, 1987-90 use 53003956

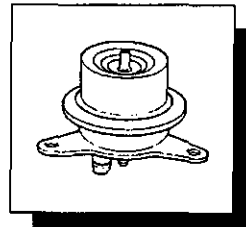

4.920

REGULATOR KIT, Pressure

4 Cyl : XJ, 1986-90 use 83501829
 16 Cyl : XJ, 1987-90 use 83503635

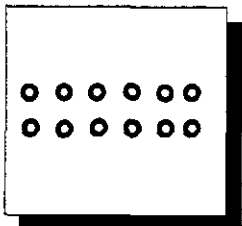

4.840

SEAL KIT, Fuel Injector

4 Cyl : XJ, 1986-90 use 83500067 ¹
 16 Cyl : XJ, 1987-90 use 83503637

NOTE: 1. USE ONE SEAL KIT PER INJECTOR.
 6 CYL. KIT CONTAINS SEALS FOR 6 INJECTORS.

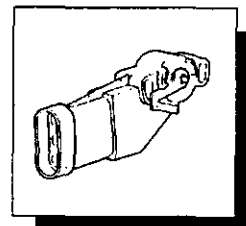

4.920

SENSOR KIT, Throttle Body

4 Cyl : XJ, 1986 use 33000169
 4 Cyl : XJ, 1987-90 use 33000169 ¹
 4 Cyl : XJ, 1987 use 53003425 ²
 4 Cyl : XJ, 1988-90 use 33004531 ²

16 Cyl : XJ, 1987-90 use 33003194 ¹
 16 Cyl : XJ, 1987-90 use 33004650 ²

NOTE: 1. WITH MANUAL TRANSMISSION.
 2. WITH AUTOMATIC TRANSMISSION.

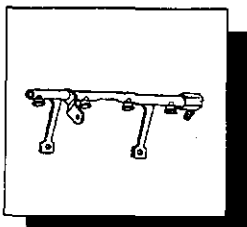

4.898

RAIL ASSY, Multi Port Injection

16 Cyl : XJ, 1987-90 use 83503636

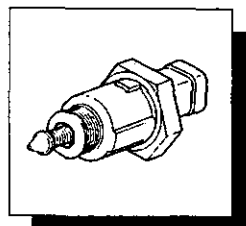

4.922

MOTOR KIT, Idle Air By-Pass

16 Cyl : XJ, 1987-90 use 83503643

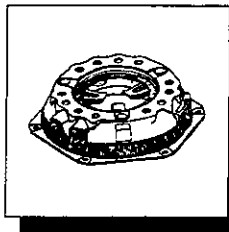

5.001

COVER, Clutch

6 Cyl : SJ, 1979-81 use J5357436 ¹
 6 Cyl : SJ, 1982-90 use J3240277
 8 Cyl : SJ, 1979-85 use J3184955 ²
 8 Cyl : SJ, 1986-90 use J3240277

4 Cyl : XJ, 1984-90 use 53003006
 V6 Cyl : XJ, 1984-85 use 83500804
 V6 Cyl : XJ, 1986 use 83501947
 I6 Cyl : XJ, 1987-90 use 53004678
 Diesel : XJ, 1984-90 use T0723977

NOTE: 1. FOR 1981, WITH 10-1/2" USE J3184908. WITH 11" USE J5357436.
 2. FOR V8-304 USE J3184908.

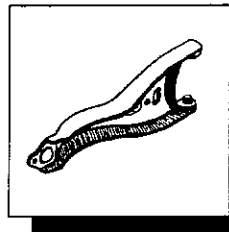

5.123

LEVER, Clutch Throwout

6 Cyl : SJ, 1979 use J3217480
 6 Cyl : SJ, 1980-90 use J5361620
 8 Cyl : SJ, 1979 use J3217480
 8 Cyl : SJ, 1980-90 use J5361620

4 Cyl : XJ, 1984-86 use 53000484
 V6 Cyl : XJ, 1984-86 use 53000484
 Diesel : XJ, 1984-90 use 53000484

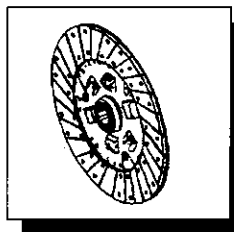

5.040

PLATE, Driven

6 Cyl : SJ, 1979-81 use J5357437 ¹
 6 Cyl : SJ, 1982-86 use J3240278
 6 Cyl : SJ, 1987-89 use 53001486
 8 Cyl : SJ, 1979-86 use J3184867 ²
 8 Cyl : SJ, 1987-90 use 53001486

4 Cyl : XJ, 1984-90 use 53004538
 V6 Cyl : XJ, 1984-1986 use 53008166
 I6 Cyl : XJ, 1987-90 use 53004679
 Diesel : XJ, 1984-90 use T0729376

NOTE:
 1. FOR 1981, 10 1/2" USE J5360174.
 WITH 11" USE J5357437.
 2. FOR V8-304 USE J5360173.

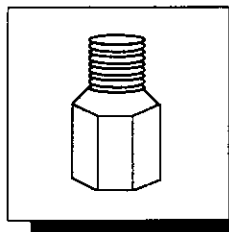

5.130

PIVOT ASSY, Clutch Throwout

6 Cyl : SJ, 1979-80 use J3184913
 8 Cyl : SJ, 1979-80 use J3184913

4 Cyl : XJ, 1984-86 use J3217479
 V6 Cyl : XJ, 1984-86 use J3217479
 Diesel : XJ, 1984-90 use J3217479



5.130

BALL, Throwout Lever

6 Cyl : SJ, 1979-90 use J0169162
 8 Cyl : SJ, 1979-90 use J0169162

4 Cyl : XJ, 1984-89 use J0169162
 V6 Cyl : XJ, 1984-86 use J0169162
 I6 Cyl : XJ, 1987-90 use J0169162
 Diesel : XJ, 1984-90 use J0169162

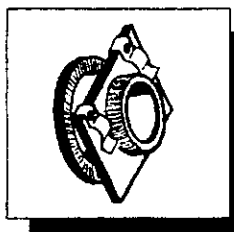

5.109

SLEEVE, Clutch Throwout Lever with Bearing

6 Cyl : SJ, 1979 use J3190517
 6 Cyl : SJ, 1980-90 use J5361610
 8 Cyl : SJ, 1979 use J3190517
 8 Cyl : SJ, 1980-90 use J5361610

4 Cyl : XJ, 1984-86 use 53000175
 V6 Cyl : XJ, 1984-86 use 53001092
 Diesel : XJ, 1984-90 use 53001162

(XJ : 1987-90, See 5.221 - Slave Cyl.)

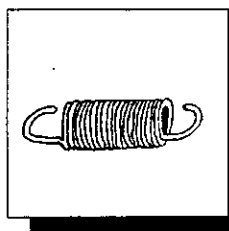

5.132

SPRING, Clutch Throwout

6 Cyl : SJ, 1979 use J3199503
 6 Cyl : SJ, 1980-90 use J3222799
 8 Cyl : SJ, 1979 use J3199503
 8 Cyl : SJ, 1980-90 use J3222799

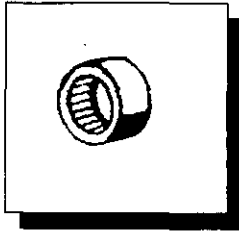

5.135

BEARING, Clutch Pedal

6 Cyl : SJ, 1979-89 use J0949169
8 Cyl : SJ, 1979-89 use J0949169

4 Cyl : XJ, 1984-90 use J3225981¹
V6 Cyl : XJ, 1984-86 use J3225981¹
16 Cyl : XJ, 1987-90 use J3225981¹
Diesel : XJ, 1984-90 use J3225981¹

NOTE: 1. BUSHING.

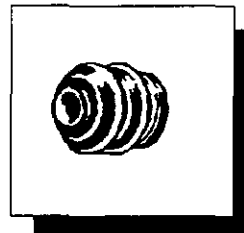

5.168

BOOT, Clutch Pivot Inner & Outer

6 Cyl : SJ, 1979-90 use J3167049
8 Cyl : SJ, 1979-90 use J3167049

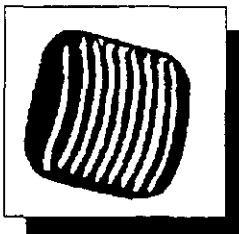

5.144

PAD, Clutch Pedal

6 Cyl : SJ, 1979-81 use J0948758
6 Cyl : SJ, 1982-90 use J5363508
8 Cyl : SJ, 1979-81 use J0948758
8 Cyl : SJ, 1982-90 use J5363508

4 Cyl : XJ, 1984-86 use J3229581
4 Cyl : XJ, 1987-90 use 52002750
V6 Cyl : XJ, 1984-86 use J3229581
V6 Cyl : XJ, 1987 use 52002750
16 Cyl : XJ, 1986 use J3229581
16 Cyl : XJ, 1987-90 use 52002750
Diesel : XJ, 1984-86 use J3229581
Diesel : XJ, 1987-90 use 52002750

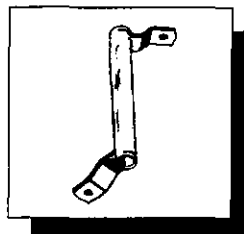

5.168

BELLCRANK, Clutch Release Idler with Manual Transmission

6 Cyl : SJ, 1979 use J5354027¹
6 Cyl : SJ, 1980-81 use J5359730
6 Cyl : SJ, 1982-90 use J5363971
8 Cyl : SJ, 1979 use J5354027²
8 Cyl : SJ, 1980-90 use J5359730

NOTE: 1. USED WITH GEAR SHIFT ROD 16-7/8" LONG. WITH GEAR SHIFT ROD 17-5/8" LONG USE J5357458. WITH SELF-LOCKING PIN IN CLUTCH ROD USE J5359896.
2. USED WITH GEAR SHIFT ROD 16-7/8" LONG. WITH GEAR SHIFT ROD 17-5/8" LONG USE J5357459. WITH SELF-LOCKING PIN IN CLUTCH ROD USE J5359893.

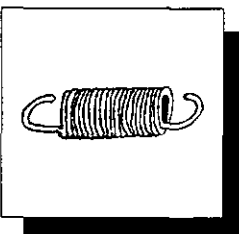

5.155

SPRING, Clutch Pedal Over Center

6 Cyl : SJ, 1979-90 use J5351118
8 Cyl : SJ, 1979-90 use J5351118

4 Cyl : XJ, 1984-90 use 52000402
V6 Cyl : XJ, 1984-87 use 52000402
16 Cyl : XJ, 1986-90 use 52000402
Diesel : XJ, 1984-90 use 52000402

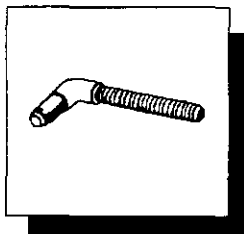

5.187

ROD ASSY, Clutch Fork Release

6 Cyl : SJ, 1979 use J5359939¹
6 Cyl : SJ, 1980-81 use J5361739
6 Cyl : SJ, 1982-90 use J5363460
8 Cyl : SJ, 1979 use J5359937²
8 Cyl : SJ, 1980-86 use J5360098
8 Cyl : SJ, 1987-90 use J5363460

NOTE: 1. 8-5/32" LONG USE J5351274.
2. WITH NUT TYPE ATTACHMENT USE J5351211.

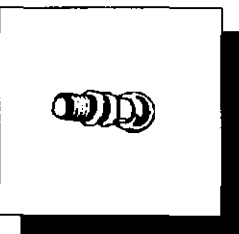

5.168

PIVOT, Clutch Release Idler

6 Cyl : SJ, 1979-90 use J0944666
8 Cyl : SJ, 1979-90 use J0944666

4 Cyl : XJ, 1984-87 use J3217479
V6 Cyl : XJ, 1984-86 use J3217479
16 Cyl : XJ, 1987 use J3217479
Diesel : XJ, 1984-87 use J3217479

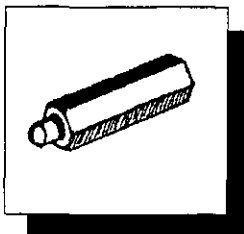

5.187

ADJUSTER, Clutch Wear

6 Cyl : SJ, 1979 use J5351209
6 Cyl : SJ, 1980-90 use J5359735
8 Cyl : SJ, 1979 use J5351209
8 Cyl : SJ, 1980-90 use J5359735

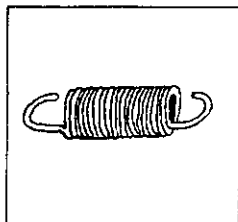

5.190

SPRING, Clutch Throwout Lever

6 Cyl : SJ, 1979-89 use J5351252
8 Cyl : SJ, 1979-89 use J5351252

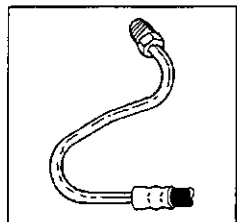

5.221

HOSE, Clutch Master Cylinder to Clutch Slave Cylinder

4 Cyl : XJ, 1984-86 use 53004247
4 Cyl : XJ, 1987-89 use 53004900
V6 Cyl : XJ, 1984-86 use 53004247
I6 Cyl : XJ, 1987-89 use 53004504
I6 Cyl : XJ, 1989-90 use 53005923
Diesel : XJ, 1984-85 use 53001323
Diesel : XJ, 1986-89 use 53004161
Diesel : XJ, 1990 use 53005923

NOTE: 1. WITH AISIN TRANSMISSION.

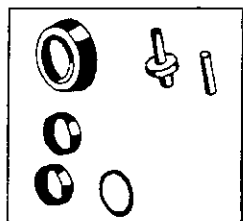

5.211

REPAIR KIT, Clutch Master Cylinder

4 Cyl : XJ, 1984-85 use 83500669
4 Cyl : XJ, 1986 use 83501531
4 Cyl : XJ, 1987-90 use 83504097
V6 Cyl : XJ, 1984-86 use 83501531
I6 Cyl : XJ, 1987-90 use 83504097
Diesel : XJ, 1984-90 use 83501531

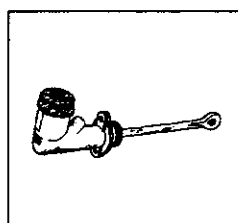

5.221

MASTER CYLINDER, Clutch

4 Cyl : XJ, 1984-85 use 52000068
4 Cyl : XJ, 1986 use 53001163
4 Cyl : XJ, 1987-90 use 53004467
V6 Cyl : XJ, 1984 use 52000068
V6 Cyl : XJ, 1985-86 use 53001163
I6 Cyl : XJ, 1987-90 use 53004467
Diesel : XJ, 1984 use 52000068
Diesel : XJ, 1985-86 use 53001163
Diesel : XJ, 1987-90 use 53004467

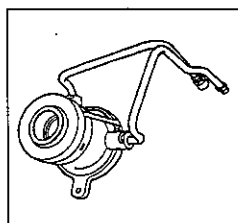

5.221

SLAVE CYLINDER, Clutch

4 Cyl : XJ, 1984-86 use 52000070
4 Cyl : XJ, 1987-90 use 83503384
V6 Cyl : XJ, 1984-86 use 52000070
I6 Cyl : XJ, 1987-89 use 83503383 1,2
I6 Cyl : XJ, 1989-90 use J5252137 2
Diesel : XJ, 1984-90 use 53001324

NOTE: 1. WITH PEUGEOT TRANSMISSION. WITH AISIN TRANSMISSION USE J5252137.
2. THIS IS A CLUTCH CONTROL UNIT CONTAINING THE CLUTCH BEARING.

TRANSMISSIONS

<u>YEAR</u>	<u>APPLICATION</u>	<u>TYPE</u>	<u>PART #</u>	<u>PAGE</u>
1979	SJ; 3-Speed	T-15A	5357438 5357727	T3
1979-86	SJ; 4-Speed	T-18	J5359568	T5
1980-86	SJ; 4-Speed	T176	J5362086	T7
1980/	SJ; 4-Speed	T-176	J5359390	T7
1981-90	SJ; 4-Speed	T-177	J5359389	T7
1980/	SJ; 4-Speed	T-178	J5359391	T7
1984-86	XJ; 4-Speed	T-4	53001547 53001548 83500340	T9
1984-86	XJ; 5-Speed	T-5	53002270	T11
1987/	XJ; 4-Speed	AX-4	See Chart	T13
1987/	XJ; 5-Speed	AX-5	See Chart	T13
1984-90	XJ; 5-Speed	AX-15	See Chart	T17
1987-89	XJ; 5-Speed	BA-10/5	See Chart	T19

T15A TRANSMISSION

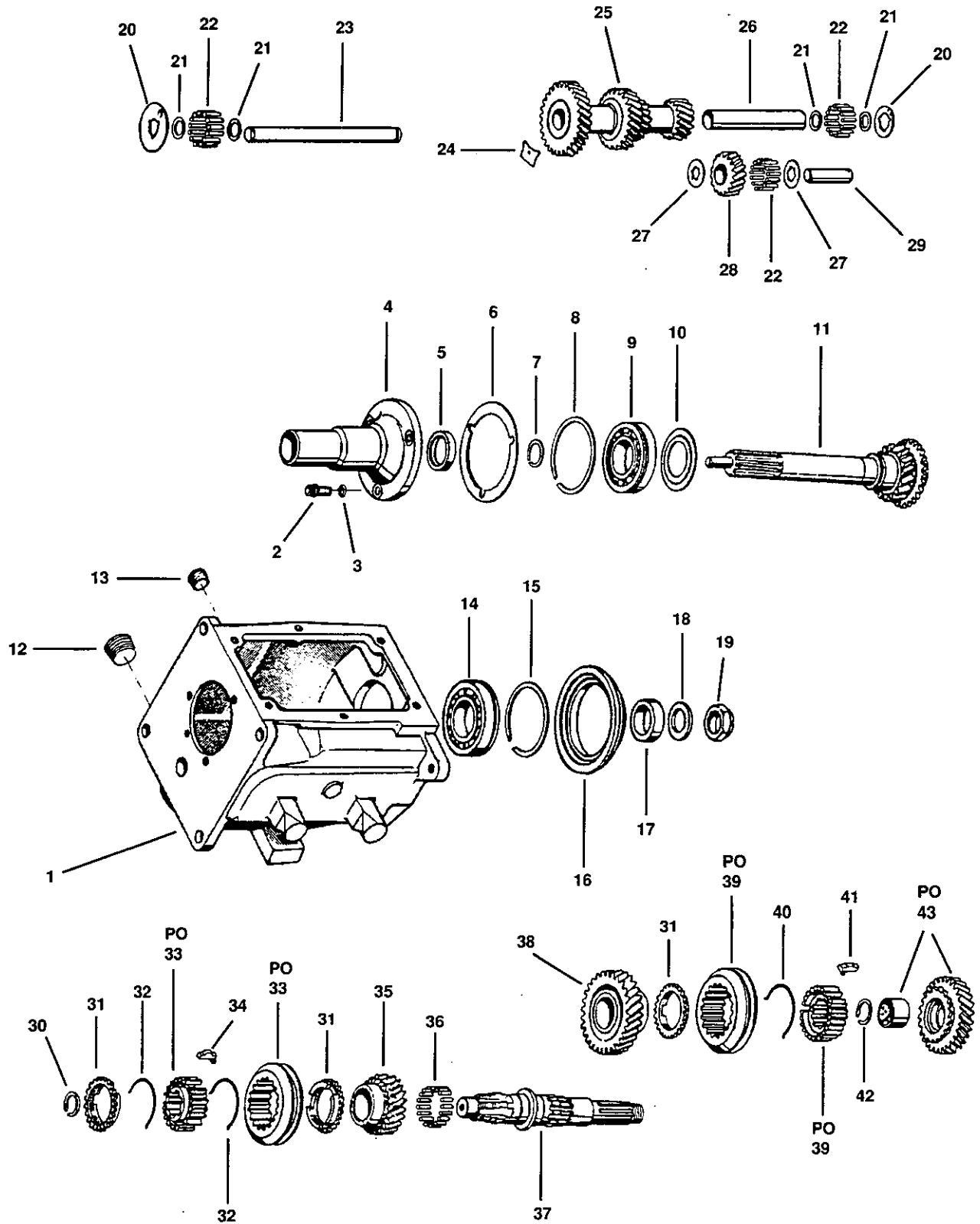

T15A TRANSMISSION

<u>REFERENCE NUMBER</u>	<u>DESCRIPTION</u>	<u>PART NUMBER</u>	
1	CASE, transmission	J0991011	
2	BOLT, retainer	J3190386	
3	GASKET, retainer bolt	51875	
4	RETAINER, front bearing	J5357462 (6 Cyl.)	J8125717 (V8 Cyl.)
5	SEAL, main drive gear	J8127391	
6	GASKET, retainer	J3192431	
7	SNAP RING	J3192351 *	
8	SNAP RING	J4488142 *	
9	BEARING, front	J4488141	
10	WASHER, oil retainer	J0640893 *	
11	GEAR, main drive	J0991061 (6 Cyl.)	J8125561 (V8 Cyl.)
12	PLUG, drain	J0991035	
13	PLUG, filler	G444592	
14	BEARING, rear	J0991076	
15	SNAP RING	J0991078 *	
16	RETAINER, rear bearing	J8123033	
17	SPACER	J0991080	
18	WASHER	JA001410	
19	NUT	J0940970	
20	WASHER, thrust	J0941662 *	
21	WASHER, rollers	J3112993 *	
22	ROLLERS	J4485673 *	
23	COUNTERSHAFT	J3192422	
24	PLATE	J3192372 *	
25	CLUSTER GEAR	J0991044	
26	SPACER, countershaft rollers	J0991046	
27	WASHER, reverse idler thrust	J0944334 *	
28	GEAR, reverse idler	J3192424	
29	SHAFT, reverse idler	J3192373	
30	SNAP RING	J3184552 *	
31	BLOCKING RING	J0991021	
32	SPRING, synchronizer	J0991017	
33	SYNCHRONIZER ASSY, 2nd & 3rd	J0991014	
34	PLATE, synchronizer	J3192412	
35	GEAR, second speed	J0991019	
36	ROLLER, main shaft	J3208152 *	
37	MAIN SHAFT	J0991013	
38	GEAR, low	J0991027	
39	SYNCHRONIZER, low & reverse	J0991031	
40	SPRING, synchronizer	J3193361	
41	PLATE, synchronizer	J3192434	
42	SNAP RING	J3182332 *	
43	GEAR ASSY, (inc. bushing)	J0991038	
44	SMALL PARTS KIT	T15A	
45	GASKET & SEAL KIT	J0991199	

* INCLUDED IN T15A SMALL PARTS KIT.

T18 TRANSMISSION

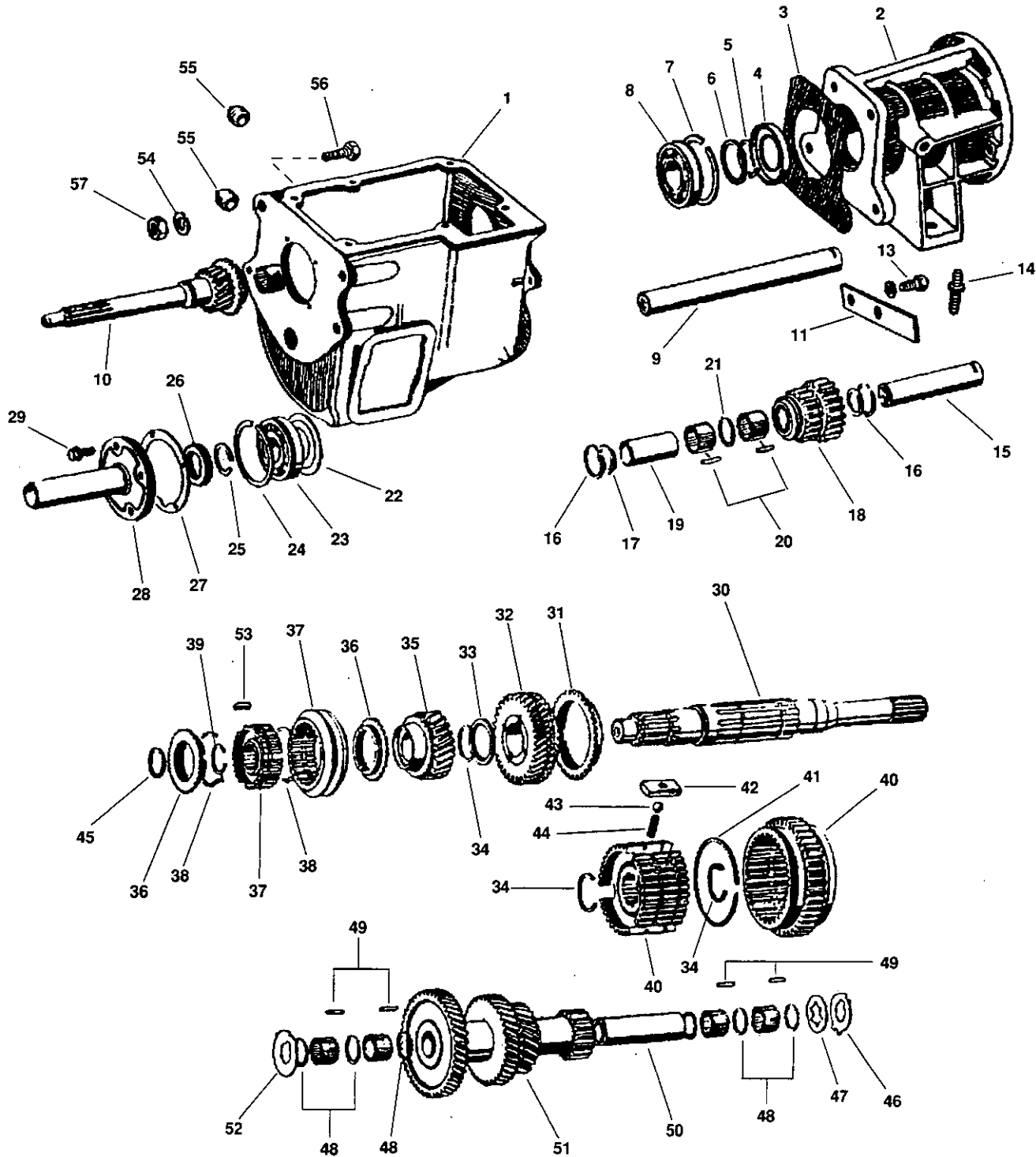

T18 TRANSMISSION

<u>REFERENCE NUMBER</u>	<u>DESCRIPTION</u>	<u>PART NUMBER BEFORE 8/22/83</u>	<u>PART NUMBER AFTER 8/22/83</u>
	TRANSMISSION ASSY	J5359568	
1	CASE, transmission	J8132648 (1)	J8132648
2	ADAPTER	J8132657 (2)	J8132657
3	GASKET	J8132658 (3)	J8132658
4	SEAL, adapter oil	J8132957 (4)	J8132957
5	SNAP RING	J8132651 *	
6	WASHER, thrust	J8132650 *	
7	RING, bearing lock	J0912342 *	
8	BEARING, bear ball	J0912341	
9	COUNTERSHAFT	J0940494	
10	SHAFT, clutch	J8132656 (5)	J8132656
11	LOCKPLATE	J8132652 *	
12	WASHER, lock	G138489	
13	BOLT	G180120	
14	STUD, mounting	J4006461	
15	SHAFT, reverse idler	J0912359	
16	SNAP RING	J0912358 *	
17	WASHER, thrust	J0012356 *	
18	GEAR, reverse idler	J0940503	
19	SLEEVE, shaft	J0912357	
20	ROLLER BEARING	J0912354 *	
21	SPACER, bearing	J0912355	
22	BAFFLE, oil	J0640893	
23	BEARING, clutch shaft	J4488141	
24	SNAP RING	J0912342 *	
25	SNAP RING	J0912363 *	
26	SEAL, front bearing oil	J8132779	
27	GASKET, front bearing cap	J0912371	
28	CAP, front bearing	J8132654 (6)	J8132654
29	BOLT, (x4)	G179817	
30	MAINSHAFT, splined	J8132649 (7)	J8132649
31	RING, 1st & 2nd synchro	J0912340	83501860
32	GEAR, second speed	J0940498	
33	WASHER, thrust	J0912332	
34	SNAP RING	J0912333 *	
35	GEAR, third speed	J8130254	
36	RING SET, 3rd & 4th synchro	J8130256	
37	CLUTCH ASSY, 3rd & 4th synch	J8130253	
38	SNAP RING	J8130257 *	
39	SNAP RING	J0912328 *	
40	CLUTCH ASSY	J0940499	83501858
41	RING, 1st & 2nd plate	J0912338	83501862
42	PLATE, 1st & 2nd synchro	J0912337	83501861
43	BALL, 1st & 2nd	G453593 *	
44	SPRING	J0917117	
45	SPACER	J0912346	
46	WASHER	J0939357 *	
47	WASHER	J0912350 *	
48	SPACER	J0912346	
49	ROLLER BEARING	J0912345 *	
50	SPACER	J0912347	
51	GEAR, countershaft	J0940502	
52	WASHER, thrust	J0912348	
53	PLATE, 3rd & 4th synchro	J3182573	
54	WASHER	G120383 *	
55	PLUG, pipe	G444592	
56	BOLT	G9419081	
57	NUT	G271501	
58	SMALL PARTS KIT	T18	
59	GASKET & SEAL KIT	J0923302	

FOOTNOTES

1. 1979 use J8130252.
2. 1979 use J0927829.
3. 1979 use J0911691.
4. 1979 use J0939335.
5. 1979, 6 cyl., use J8130259.
1979, 8 cyl., use J8130258.
1980, 6 cyl., use J8132655.
6. 1979, 6 cyl., use J5357473.
1979, 8 cyl., use J8125945.
7. 1979 use J0942937.

* Included in T18 Small Parts Kit.

T176, T177, T178 TRANSMISSION

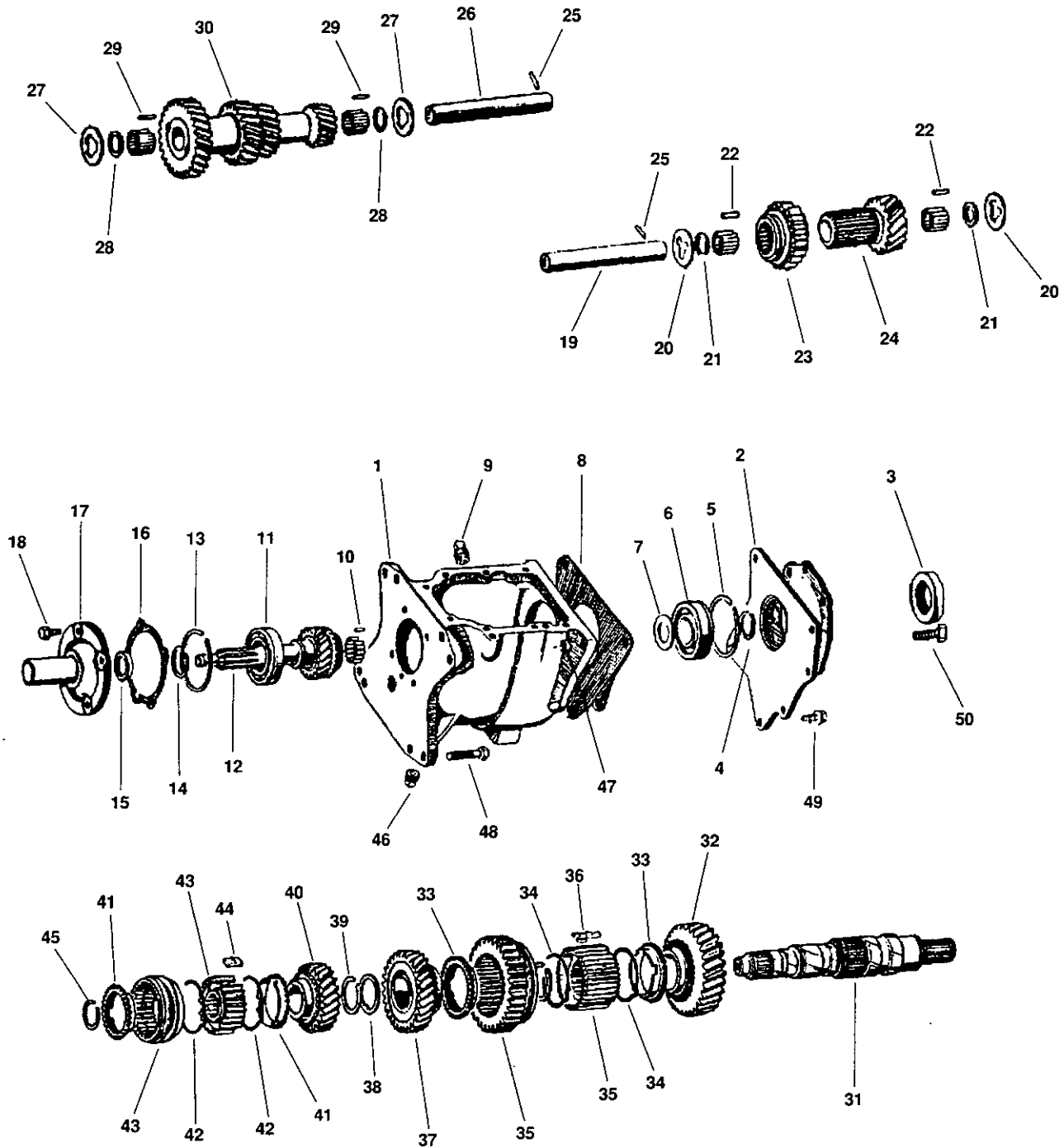

T176, T177, T178 TRANSMISSION

REFERENCE NUMBER	DESCRIPTION	T176	T176	T177	T178
	TRANSMISSION ASSY	J5362086	J5359390	J5359389	J5359391
1	CASE , transmission	J8132375	J8132375	J8132375	J8132375
2	ADAPTER	J5359381	J5359381	J5359381	J5359381
3	SEAL , adapter oil	J5359457	J5359457	J5359457	J5359457
4	SNAP RING	J8124883	J8124883	J8124883	J8124883
5	RING , rear bearing lock	J8132430	J8132430	J8132430	J8132430
6	BEARING , rear	J8132431	J8132431	J8132431	J8132431
7	WASHER , thrust	J8132390	J8132390	J8132390	J8132390
8	GASKET , trans to adapter	J5359411	J5359411	J5359411	J5359411
9	PLUG , drain or fill	G438159	G438159	G438159	G438159
10	ROLLER BEARING	J8124929	J8124929	J8124929	J8124929
11	BEARING , front	J8132426	J8132426	J8132426	J8132426
12	SHAFT , clutch	J8133434	J8133434 *	J8132401	J8132370
13	RING , front bearing lock	J8132425	J8132425	J8132425	J8132425
14	SNAP RING	J08132427	J8132427	J8132427	J8132427
15	SEAL , front bearing lock	J8124881	J8124881	J8124881	J8124881
16	GASKET , bearing cap	J8132423	J8132423	J8132423	J8132423
17	CAP , front bearing	J8132372	J8132372	J8132372	J8132372 (6 Cyl.) J8132373 (8 Cyl.)
18	BOLT (x4)	J8132424	J8132424	J8132424	J8132424
19	SHAFT , reverse idler	J8132398	J8132398	J8132398	J8132398
20	WASHER , thrust	J8132405	J8132405	J8132405	J8132405
21	WASHER , flat	J8132404	J8132404	J8132404	J8132404
22	ROLLER BEARING	J8132403	J8132403	J8132403	J8132403
23	GEAR , reverse sliding	J8132402	J8132402	J8132402	J8132402
24	GEAR , reverse idler	J8132399	J8132399	J8132399	J8132399
25	PIN , shaft	J8124931	J8124931	J8124931	J8124931
26	SHAFT , counter	J8132397	J8132397	J8132397	J8132397
27	WASHER , thrust	J8132396	J8132396	J8132396	J8132396
28	WASHER , flat	J8132395	J8132395	J8132395	J8132395
29	ROLLER BEARING	J8132394	J8132394	J8132394	J8132394
30	GEAR , countershaft	J8132391	J8132391	J8132393	J8132392
31	SHAFT , spline	J8132374	J8132374	J8132374	J8132374
32	GEAR , first speed	J8132389	J8132389	J8132389	J8132389
33	RING SET , 1st & 2nd sync	J8132378	J8132378	J8132378	J8132378
34	SPRING , 1st & 2nd sync	J8132377	J8132377	J8132377	J8132377
35	SYNCHRONIZER , 1st & 2nd	J8132386	J8132386	J8132386	J8132386
36	PLATE , 1st & 2nd sync	J8132387	J8132387	J8132387	J8132387
37	GEAR , second speed	J8132382	J8132382	J8132384	J8132383
38	WASHER , second gear	J8124936	J8124936	J8124936	J8124936
39	SNAP RING	J8132385	J8132385	J8132385	J8132385
40	GEAR , third speed	J8132379	J8132379	J8132429	J8132380
41	RING SET , 3rd & 4th sync	J8132378	J8132378	J8132378	J8132378
42	SPRING , 3rd & 4th sync	J8132377	J8132377	J8132377	J8132377
43	SYNCHRONIZER , 3rd & 4th	J8132376	J8132376	J8132376	J8132376
44	PLATE , 3rd & 4th sync	J8124895	J8124895	J8124895	J8124895
45	SNAP RING	J8124930	J8124930	J8124930	J8124930
46	PLUG , drain or fill	G438159	G438159	G438159	G438159
47	NUT	J4002256	J4002256	J4002256	J4002256
48	BOLT	G180147	G180147	G180147	G180147
49	BOLT	J4001884	J4001884	J4001884	J4001884
50	BOLT	G180137	G180137	G180137	G180137
51	SMALL PARTS KIT	SP170-50	SP170-50	SP170-50	SP170-50
52	GASKET & SEALS KIT	T-170-GS	T-170-GS	T-170-GS	T-170-GS

* For 1980 use J8132369.

T-4 TRANSMISSION

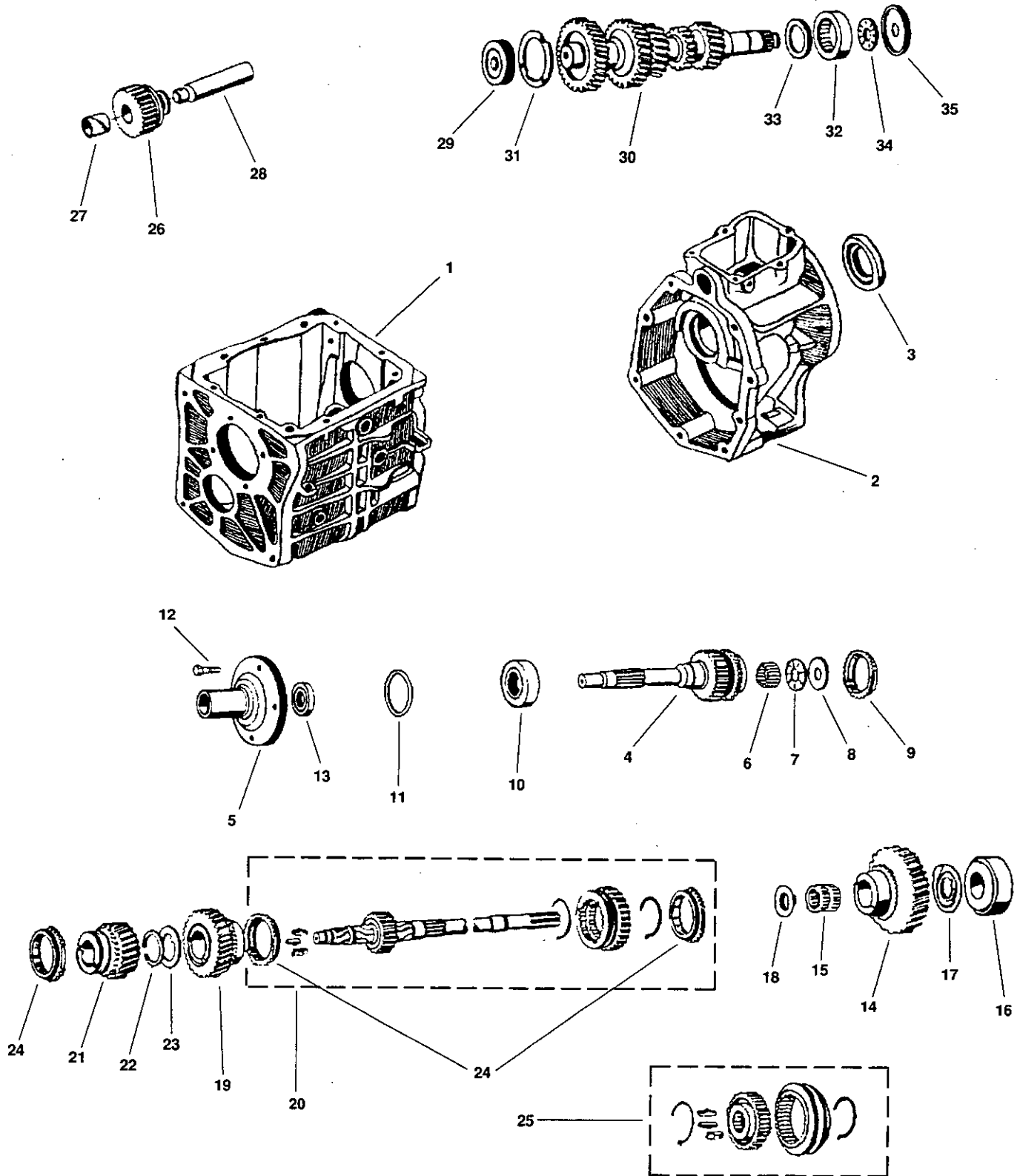

T-4 TRANSMISSION

REFERENCE NUMBER	DESCRIPTION	TAG NUMBER:	
		8953000325 <u>8953001128</u>	8953001547 8953001548 <u>8953002269</u>
	TRANSMISSION ASSY		83500340
1	CASE, transmission	J8134009 *	J8134009 *
2	ADAPTER	83510185	83510185
3	SEAL, adapter	J8132672	J8132672
4	SHAFT, input	83500968 *	83500968 *
5	RETAINER	J8134013	J8134013
6	ROLLER BEARING	J8127397	J8127397
7	BEARING, thrust	J8134018	J8134018
8	RACE, thrust washer	J8134017	J8134017
9	RING SET, blocking (x2)	J8134058	J8134058
10	BEARING	J8134015	J8134015
11	SHIM SET, (x8) (Incl. 8 pieces)	J8134016	J8134016
12	SCREW, (x4)	J8127393	J8127393
13	SEAL	J8132779	J8132779
14	GEAR, 1st	83501103	83500965
15	BEARING	83500969	83500969
16	BEARING	J8134030	J8134030
17	WASHER, thrust	83500964	83500964
18	RACE, thrust washer	83500962	83500962
19	GEAR, 2nd	J8134024	J8134024
20	MAINSHAFT ASSY	83501166	83501944
21	GEAR, 3rd (27 teeth)	83500380	83500380
	GEAR, 3rd (29 teeth; 1982-83)	83500285	83500285
22	SNAP RING	J8127424	J8127424
23	WASHER, thrust	J8134025	J8134025
24	RING SET, blocking (2x) 1st & 2nd	J8127403	J8127403
25	SYNCH. ASSY, 3rd & 4th	83510192	83510192
26	GEAR, reverse	J8134038	J8134038
27	BUSHING	J8134336	J8134336
28	SHAFT	J8134039	J8134039
29	BEARING	J8134033	J8134033
30	GEAR, cluster (37-32 teeth)	83500970	83500970
	GEAR, cluster 1982-83	J8134031	J8134031
31	WASHER, thrust	J8134032	J8134032
32	BEARING	J8134036	J8134036
33	SPACER	J8134035	J8134035
34	BEARING	J8134034	J8134034
35	RACE, thrust washer	J8134037	J8134037
36	SMALL PARTS KIT	T4-50	T4-50

* With System Sentry use 83500340.

* 1982-83 (ALL) use 83500975; 1984-86 (6 cyl.) use 83500975; 1984-86 (4 cyl.) use 83500968.

T-5 TRANSMISSION

REFERENCE NUMBER	DESCRIPTION	TAG NO: 3241888	TAG NO:	TAG NO:
			53001130 53001131 53000408	53001551 53001552 53002270
1	CASE, transmission	J8134093 *	J8134093 *	J8134093 *
2	ADAPTER	J8134095	J8134095	J8134095
3	SEAL, adapter	J8132672	J8132672	J8132672
4	GEAR, reverse idler	J8134038	J8134038	J8134038
5	BUSHING, reverse idler	J8134336	J8134336	J8134336
6	SHAFT, reverse idler	J8134039	J8134039	J8134039
7	SHAFT, input	83500975 (10 spline)	83500968 (14 spline)	83500968 (14 spline)
8	RETAINER	J8134013	J8134013	J8134013
9	SHIM KIT, (x8)	J8134016	J8134016	J8134016
10	BEARING, input shaft	J8134015	J8134015	J8134015
11	ROLLER BEARING	J8127397	J8127397	J8127397
12	BEARING, thrust	J8134018	J8134018	J8134018
13	RACE, thrust	J8134017	J8134017	J8134017
14	RING SET, 3rd & 4th synchro	J8134058	J8134058	J8134058
15	SPRING, synchro	J8134021	J8134021	J8134021
16	SYNCHRONIZER ASSY, 3rd & 4th	J8134027	83510192	83510192
17	PLATE, synchro	J8127418	J8127418	J8127418
18	GEAR, 3rd speed	J8134026 (29 teeth)	83500380 (27 teeth)	83500380 (27 teeth)
19	SNAP RING	J8127424	J8127424	J8127424
20	WASHER, thrust	J8134025	J8134025	J8134025
21	GEAR, 2nd speed	J8134024	J8134024	J8134024
22	RING SET, 1st & 2nd synchro	J8127403	J8127403	J8127403
23	MAINSHAFT ASSY	83501166	83501166	83501944
24	PLATE, synchro	J8127401	J8127401	J8127401
25	PIN, (1/8" - 3/8")	J8127427	J8127427	J8127427
26	GEAR, 1st speed	83501103	83501103	83500965
27	WASHER, thrust	J8134023	J8134023	J8134023
28	BEARING, rear	J8134030	J8134030	J8134030
29	GEAR, 5th speed driven	J8134080 (23 teeth)	J8134081 (25 teeth)	J8134081 (25 teeth)
30	SNAP RING	J8134082	J8134082	J8134082
31	ROLLER BEARING	J8134071	J8134071	J8134071
32	WASHER, thrust	J8134070	J8134070	J8134070
33	GEAR, cluster (37-34 teeth) (37-32 teeth)	J8134069	83500967	83500967
34	SPACER	J8134035	J8134035	J8134035
35	ROLLER BEARING	J8134036	J8134036	J8134036
36	SPACER	J8134072	J8134072	J8134072
37	SNAP RING	J8134073	J8134073	J8134073
38	GEAR, 5th speed drive	J8134083 (53 teeth)	J8134084 (51 teeth)	J8134084 (51 teeth)
39	RING, 5th speed	J8127414	J8127414	J8127414
40	SYNCHRONIZER ASSY, 5th	J8134086	J8134086	J8134086
41	PLATE, synchro	J8127418	J8127418	J8127418
42	SPRING, synchro	J8127419	J8127419	J8127419
43	RETAINER, strut	J8134087	J8134087	J8134087
44	RACE, thrust	J8134088	J8134088	J8134088
45	BEARING, thrust	J8134034	J8134034	J8134034
46	RACE, thrust	J8134037	J8134037	J8134037
47	SNAP RING	J8134089	J8134089	J8134089
48	FUNNEL	J8134090	J8134090	J8134090
49	FORK, 5th speed	J8134085	J8134085	J8134085
50	PIN, (3/16" x 1")	J8134040	J8134040	J8134040
51	RAIL ASSY	J8134079	J8134079	J8134079
52	FORK ASSY, reverse	83500284	83500284	83500284
53	SPRING, reverse lock	J8134076	J8134076	J8134076
54	LEVER, 5th speed	J8134075	J8134075	J8134075
55	HOOK, reverse lock	J8134077	J8134077	J8134077
56	PLATE, reverse lock	J8134078	J8134078	J8134078
57	RING, retainer	J8127469	J8127469	J8127469
58	INSERT	J8133418	J8133418	J8133418
59	BOLT	J8134098	J8134098	J8134098
60	PIN, (3/16" x 1")	J8134040	J8134040	J8134040
61	BREATHER	J0912375	J0912375	J0912375
62	PIN, pivot	J8134041	J8134041	J8134041
63	SWITCH, backup light	J8134068	J8134068	J8134068
64	BOLT	J4006682	J4006682	J4006682
65	PLUG, pipe	J8128343	J8128343	J8128343
66	SMALL PARTS KIT	T5-50	T5-50	T5-50

* 1984-86 with System Sentry use 83500980.

AX-4, AX-5 TRANSMISSION

REFERENCE NUMBER	DESCRIPTION	AX-4	AX-4	AX-4	AX-5	AX-5	AX-5
		1984-86	'87-11/4/88	11/5/88-'90	1984-86	'87-10/4/88	10/5/88-'90
		TAG NO: 53001565 53002264	TAG NO: 53003023 53004119	TAG NO: 53006168 (1) 53006172 (2)	TAG NO: 53001565 53002265 53001190 53000671	TAG NO: 53003024 53003386 53003388 53004224 53004358 53004359	TAG NO: 53006173 53006174
1	CASE, transmission (21)	83500502	83500502	83506015	83500634	83500634	83506016
2	ADAPTER (22)	83500616	83503629	83506037	83503629	83503629	83506038
3	SEAL, adapter	83503108	83503108	83503108	83500620	83503108	83503108
4	RETAINER	83500633	83503112	83503112	83500633	83503112	83503112
5	GASKET, transmission	83500506	83500506	83500506	83500506	83500506	83500506
6	GASKET, adapter	83500507	83500507	83500507	83500507	83500507	83500507
7	GASKET, retainer	83500505	83500505	83500505	83500505	83500505	83500505
8	PLUG, drain	83500509	83500509	83500509	83500509	83500509	83500509
9	RETAINER				83500508	83500508	83506034
10	GEAR, 5th				83500971	83500971	83500971
11	SNAP RING						
	W = 2.67 mm				83500587	83500587	83500587
	W = 2.73 mm				83500588	83500588	83500588
	W = 2.79 mm				83500589	83500589	83500589
	W = 2.85 mm				83500590	83500590	83500590
	W = 2.91 mm				83500591	83500591	83500591
	W = 2.97 mm				83500592	83500592	83500592
	W = 3.03 mm				83500593	83500593	83500593
	W = 3.09 mm				83500594	83500594	83500594
	W = 3.15 mm				83500595	83500595	83500595
	W = X 3.21 mm				83500596	83500596	83500596
	W = 3.27 mm				83500597	83500597	83500597
12	SNAP RING	83500613	83500613	83500613	83500613	83500613	83500613
13	BEARING, rear	83500575	83500575	83506030 (3)	83500575	83500575	83506030 (10)
14	RACE, 1st gear	83500560	83500560	83506026 (4)	83500560	83500560	83506026
15	BALL, reverse	83500573	83500573	83500573	83500573	83500573	83500573
16	MAINSHAFT	83500559	83503105	83503105 (5)	83500559 (11)	83503105 (12)	83503105 (12)
17	BEARING	83500577	83500577	83500577	83500577	83500577	83500577 (13)
18	GEAR, 2nd	83500551	83500551	83506018 (6)	83500551	83500551	83506018
19	BLOCKING RING	83500567	83500567	83500567	83500567	83500567	83500567
20	SPRING, synchronizer	83500569	83500569	83500569	83500569	83500569	83500569
21	SYNCHRONIZER, 1st & 2nd	83500561	83500561	83500561	83500561	83500561	83500561
22	KEY, synchronizer	83500564	83500564	83500564	83500564	83500564	83500564
23	GEAR, reverse	83500555	83500555	83500555	83500555	83500555	83500555
24	GEAR, 1st speed	83500550	83500550	83506017 (7)	83500550	83500550	83506017 (14)
25	BEARING, 1st gear	83500578	83500578	83506031 (8)	83500578	83500578	83506031 (15)
26	SNAP RING						
	W = 2.05 mm	83500645	83500645	83500645	83500645	83500645	83500645
	W = 2.10 mm	83500645	83500607	83500607	83500645	83500607	83500607
	W = 2.15 mm	83500608	83500608	83500608	83500608	83500608	83500608
	W = 2.20 mm	83500609	83500609	83500609	83500609	83500609	83500609
	W = 2.25 mm	83500610	83500610	83500610	83500610	83500610	83500610
	W = 2.30 mm	83500611	83500611	83500611	83500611	83500611	83500611
27	SNAP RING	83500614	83500614	83500614	83500614	83500614	83500614
28	BEARING, front	83500643	83502681	83502681	83500643	83502681 (16)	83502681 (16)
29	GEAR, main drive (23)	83500554	83502682	83502682 (9)	83500554 (17)	83502682 (18)	83502682 (19)
30	RING, synchronizer	83500566	83500566	83500566	83500566	83500566 (22)	83500566 (20)
31	SEAL	83506045	83506045	83506045	83506045	83506045	83506045

NOTES:

- (1). Trans assy is 4x2.
- (2). Trans assy is 4x4.
- (3). 4x2 only. For 4x4, use 83500575.
- (4). 4x2 only. For 4x4, use 83500560.
- (5). For 4x2, use 83502117.
- (6). For 4x4, use 83500551.
- (7). For 4x4, use 83500550.
- (8). For 4x4, use 83500578.
- (9). For 4x2, use 83506020.
- (10). 4 Cyl. use 83506030.
6 Cyl. use 83506074.
- (11). For 4x2, use 83502117.
- (12). For 4x4, 4 Cyl., use 83503105.
For 4x4, 6 Cyl., use 83506243.
For 4x2, 4 Cyl., use 83502117.

NOTES:

- (13). 4 Cyl., use 83506018.
6 Cyl., use 5252078.
- (14). 4 Cyl., use 83506017.
6 Cyl., use 5252077.
- (15). 4 Cyl., use 83506031.
6 Cyl., use 83506075.
- (16). 4 Cyl., use 83502681.
6 Cyl., use 83506073.
- (17). 1985 Diesel, use 83501409.
- (18). 1986-87 Diesel, use 83502683.
- (19). 10/5/88 and Up : 4 Cyl., use 83502682.
6 Cyl., use 5252081.
- (20). 6 Cyl., use 83506253.
(83500566 is w/ 4 Cyl.)

NOTES:

- (21). Case - 83506015 is with 4x2. 83500502 is with 4x4.
- (22). Adapter - 83506013 is for 4x2 (AX4:1988/90).
(AX4:'88/'90)83503629 is for 4x4; Trans tag # 53004119.
(AX4:'88/'90)83506037 is for 4x4; Trnas tag # 53006172.
(AX5:1987/90) 4 Cyl., use 83506014.
(AX5:1987/90) 6 Cyl., use 83506223.
(AX5:1987/90) Diesel, use 83503629.
- (23). Gear, Main Drive -
(AX4:1984/86) For 4x2, use 83502682.
(AX4:1984/86) For Gas use 83500554.
(AX4:1984/86) For Diesel, use 83501409.
(AX4:1987/88) For Diesel, use 83502683.

AX-4, AX-5 TRANSMISSION

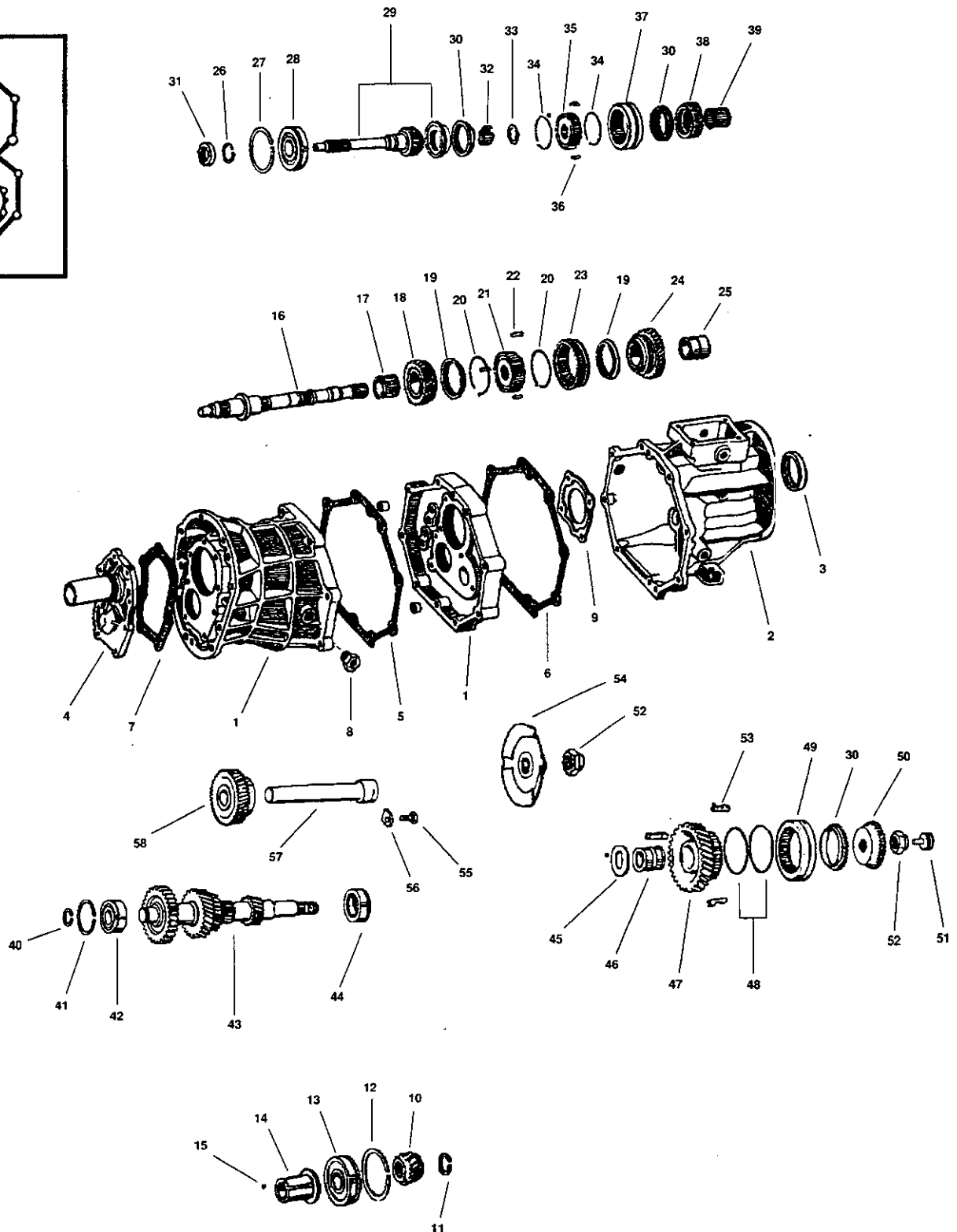
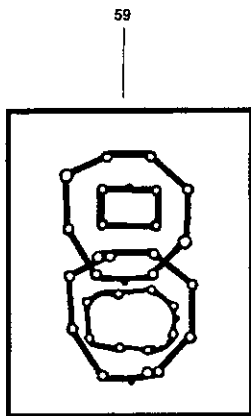

AX-4, AX-5 TRANSMISSION

REFERENCE NUMBER	DESCRIPTION	AX-4	AX-4	AX-4	AX-5	AX-5	AX-5
		1984-86	'87-11/4/88	11/5/88-'90	1984-86	'87-10/4/88	10/5/88-'90
						TAG NO: 53003024	
						TAG NO: 53001565	
						53002265	
						53001190	
						53000671	
							TAG NO: 53003386
							53003388
							53004224
							53004358
							53006174
							TAG NO: 53006173
							53006174
32	ROLLER, (x14)	83500574	83502680	83502680	83500574	83502680	83502680
33	SNAP RING						
	W = 1.75 mm	83500598	83500598	83500598	83500598	83500598	83500598
	W = 1.80 mm	83500599	83500599	83500599	83500599	83500599	83500599
	W = 1.85 mm	83500602	83500602	83500602	83500602	83500602	83500602
	W = 1.90 mm	83500603	83500603	83500603	83500603	83500603	83500603
	W = 1.95 mm	83500604	83500604	83500604	83500604	83500604	83500604
	W = 2.00 mm	83500605	83500605	83500605	83500605	83500605	83500605
	W = 2.05 mm	83500606	83500606	83500606	83500606	83500606	83500606
34	SPRING, synchronizer	83500568	83500568	83500568	83500568 (5)	83500568 (5)	83500568 (5)
35	SYNCHRONIZER, 3rd & 4th	83500562	83500562	83506027 (1)	83500562	83500562	83506027 (6)
36	KEY, synchronizer	83500565	83500565	83506029 (2)	83500565	83500565	83506029
37	SLEEVE, synchronizer	83500563	83500563	83506028 (3)	83500563	83500563	83506028 (7)
38	GEAR, 3rd	83500552	83500552	83506019 (4)	83500552	83500552	83506019 (8)
39	BEARING	83500576	83500576	83500576	83500576	83500576	83500576
40	SNAP RING						
	W = 2.05 mm	83500581	83500581	83500581	83500581	83500581	83500581
	W = 2.10 mm	83500582	83500582	83500582	83500582	83500582	83500582
	W = 2.15 mm	83500583	83500583	83500583	83500583	83500583	83500583
	W = 2.20 mm	83500584	83500584	83500584	83500584	83500584	83500584
	W = 2.25 mm	83500585	83500585	83500585	83500585	83500585	83500585
	W = 2.30 mm	83500586	83500586	83500586	83500586	83500586	83500586
41	SNAP RING	83500612	83500612	83500612	83500612	83500612	83500612
42	BEARING	83506032	83506032	83506032	83506032	83506032	83506032 (9)
43	CLUSTER GEAR	83500557	83500557	83500557	83500557	83500557	83506023 (10)
44	BEARING	83500580	83500580	83500580	83500580	83500580	83506033 (11)
45	WASHER				83500640	83500640	83506025
46	BEARING				83500644	83500644	83500644
47	GEAR, Counter 5th				83500553	83506022	83506022 (12)
48	SPRING				83500568	83500568	83500568 (13)
49	SLEEVE				83500642	83500642	83500642 (14)
50	GEAR, 5th				83500639	83500639	83500639 (15)
51	FILLER, oil				83500646	83500646	83500646
52	NUT	83500572	83500572	83500572	83500572	83500572	83500572
53	KEY, synchronizer				83500641	83500641	83500641
54	SPACER	83500558	83500558	83500558			
55	BOLT	83500615	83500615	83500615	83500615	83500615	83500615
56	STOP	83500571	83500571	83500571	83500571	83500571	83500571
57	SHAFT, reverse idler	83500570	83500570	83500570	83500570	83500570	83500570 (16)
58	GEAR, reverse idler	83503556	83503555	83503555	83503555	83503555	83503555 (17)
59	GASKET KIT	83500632	83500632	83500632	83500632	83500632	83500632

NOTES:

- (1). For 4x4, use 83500562.
- (2). For 4x4, use 83500565.
- (3). For 4x4, use 83500563.
- (4). For 4x4, use 83500552.
- (5). With 6 Cyl., use 83506255.
- (6). With 6 Cyl., use 83506248.
- (7). With 6 Cyl., use 83506249.
- (8). With 6 Cyl., use 5252079.
- (9). With 6 Cyl., use 83506259.
- (10) With 6 Cyl., use 5252085.

NOTES:

- (11). With 6 Cyl., use 83506080.
- (12). With 6 Cyl., use 5252080.
- (13). With 6 Cyl., use 83506255.
- (14). With 6 Cyl., use 83506257.
- (15). 5th Gear - 10/5/88 and Up :
4 Cyl., use 83500639.
6 Cyl., use 83506242.
- (16). 6 Cyl., use 83506258.
- (17). 6 Cyl., use 5252084.

AX-15 TRANSMISSION

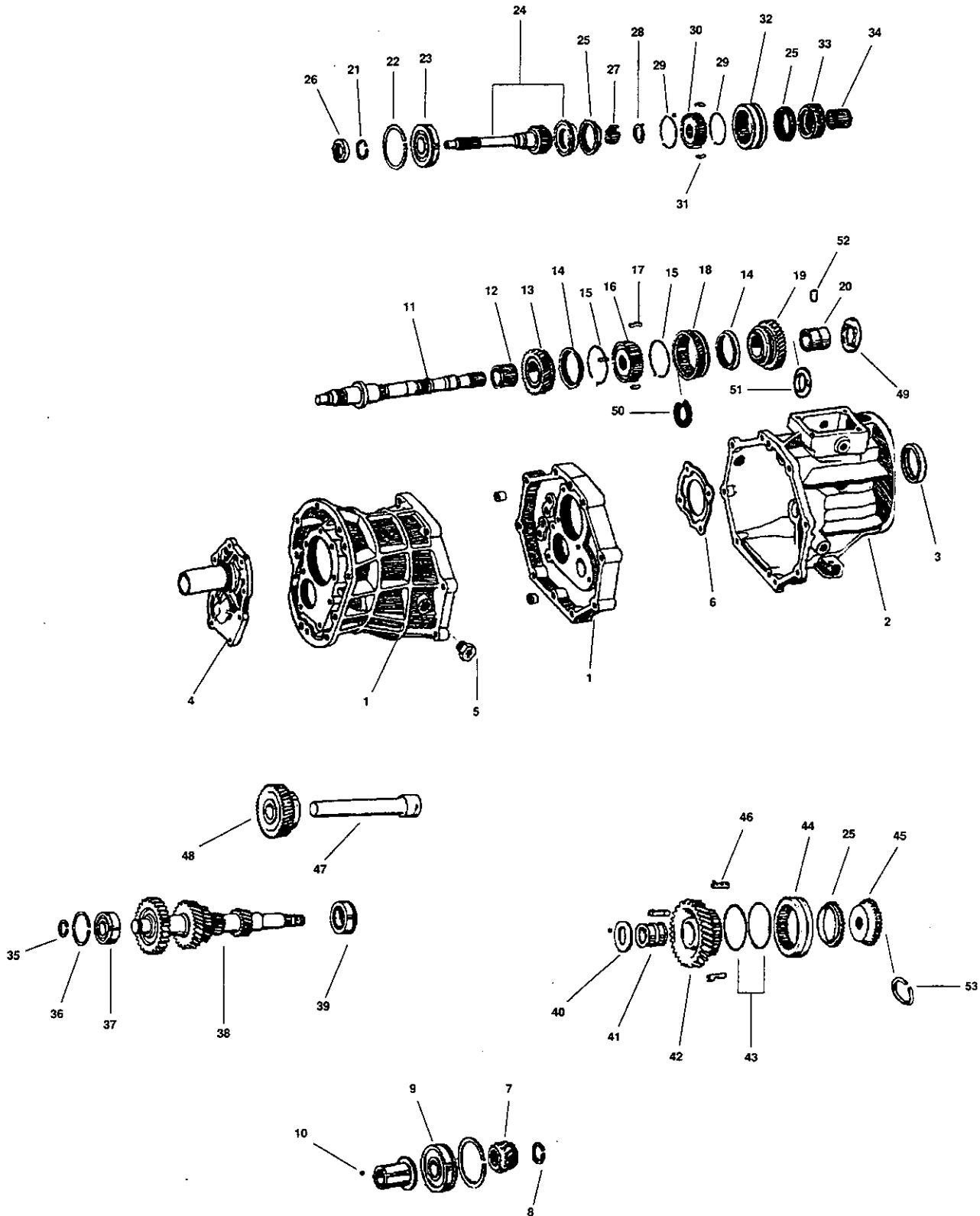

AX-15 TRANSMISSION

REFERENCE NUMBER	DESCRIPTION	TAG NO: 53005385 53005386
1	CASE, transmission	5252034
2	ADAPTER	83506223
3	SEAL, adapter	83503108
4	RETAINER	5252052
5	PLUG, drain	83500512
6	RETAINER	5252036
7	GEAR, 5th	5252083
8	SNAP RING	
	W = 2.75 mm	83506268
	W = 2.80 mm	83506269
	W = 2.85 mm	83506270
	W = 2.90 mm	83506271
	W = 2.95 mm	83506272
	W = 3.00 mm	83506273
	W = 3.05 mm	83506274
	W = 3.10 mm	83506275
	W = 3.15 mm	83506276
	W = 3.20 mm	83506277
	W = 3.25 mm	83506278
	W = 3.30 mm	83506279
9	BEARING	83506074
10	BALL, reverse	83500573
11	SHAFT, output (4WD) (2WD)	83506243 83506244
12	BEARING	83506076
13	GEAR, 2nd	5252078
14	BLOCKING RING	83506252
15	SPRING, synchronizer	83506254
16	SYNCHRONIZER, 1st & 2nd	83506247
17	KEY, synchronizer	83506250
18	GEAR, reverse	5252082
19	GEAR, 1st speed	5252077
20	BEARING	83506075
21	SNAP RING	
	W = 2.10 mm	83506099
	W = 2.15 mm	83506214
	W = 2.20 mm	83506215
	W = 2.25 mm	83506216
	W = 2.30 mm	83506217
	W = 2.35 mm	83506218
	W = 2.40 mm	83506219
22	SNAP RING	83506222
23	BEARING	83506073
24	GEAR, main drive	5252081
25	RING, synchronizer	83506253
26	SEAL	5252053
27	ROLLER, (x14)	83506078
28	SNAP RING	
	W = 1.80 mm	83506086
	W = 1.85 mm	83506087
	W = 1.90 mm	83506088
	W = 1.95 mm	83506089
	W = 2.00 mm	83506090
	W = 2.05 mm	83506091
	W = 2.10 mm	83506092

REFERENCE NUMBER	DESCRIPTION	TAG NO: 53005385 53005386
29	SPRING, synchronizer	83506255
30	SYNCHRONIZER, 3rd & 4th	83506248
31	KEY, synchronizer	83506251
32	SLEEVE, synchronizer	83506249
33	GEAR, 3rd	5252079
34	BEARING	83506077
35	SNAP RING	
	W = 2.00 mm	83506081
	W = 2.05 mm	83506082
	W = 2.10 mm	83506083
	W = 2.15 mm	83506084
	W = 2.20 mm	83506085
36	SNAP RING	83506220
37	BEARING	83506259
38	CLUSTER GEAR	5252085
39	BEARING	83506080
40	WASHER	83506245
41	BEARING	83506079
42	GEAR, Counter 5th	5252080
43	SPRING	83506254
44	SLEEVE	83506257
45	GEAR, 1st	83506242
46	KEY, synchronizer	83506256
47	SHAFT, reverse idler	83506258
48	GEAR, reverse idler	5252084
49	WASHER, thrust	83506246
50	SNAP RING	
	W = 2.35 mm	83506093
	W = 2.40 mm	83506094
	W = 2.45 mm	83506095
	W = 2.50 mm	83506096
	W = 2.55 mm	83506097
	W = 2.60 mm	83506098
51	SPACER	83506280
52	PIN	83506008
53	SNAP RING	
	W = 2.80 mm	83506260
	W = 2.85 mm	83506261
	W = 2.90 mm	83506262
	W = 3.00 mm	83506263
	W = 3.05 mm	83506264
	W = 3.10 mm	83506265
	W = 3.15 mm	83506266
	W = 3.20 mm	83506267

BA 10/5 TRANSMISSION

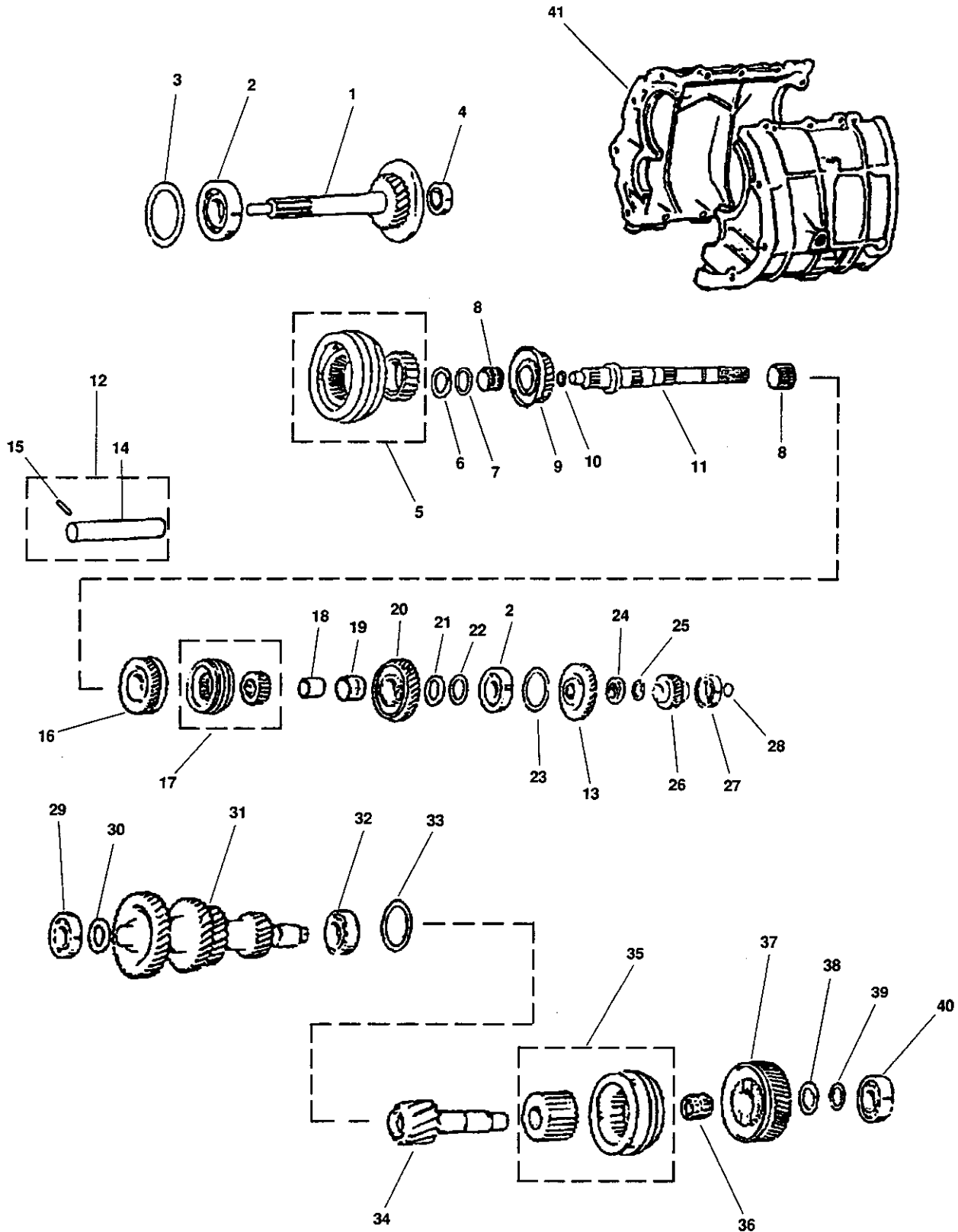

BA 10/5 TRANSMISSION

REFERENCE NUMBER	DESCRIPTION	TAG NO. UP TO 131162	TAG NO. OVER 131162
	TRANSMISSION ASSY	53003234	53005453 (2)
		53005251 (2)	53005454
		53005252	
		53002838 (2)	
1	GEAR, main drive	53005205 (3)	83505205 (3)
2	BEARING	83503212	83505447
3	SHIM KIT	83503230	83503230
4	BEARING	83504410	83504410
5	SYNCHRONIZER, 3rd & 4th gear	83504103	83504103
6	RING	83503203	83503203
7	WASHER	83504870	83504870
8	ROLLER BEARING	83503208	83503208
9	GEAR, 3rd	83503221	83503221
10	WASHER, spring	83503205	83503205
11	MAINSHAFT ---- (1)	83503219	83503219
12	GEAR KIT, reverse	83504500	83504500
13	GEAR, reverse	83503206	83503206
14	RAIL, reverse	83503262	83503262
15	PIN, reverse	83503257	83503257
16	GEAR, 2nd	83503218	83503218
17	SYNCHRONIZER, 1st & 2nd gear	83504089	83504089
18	SPACER	83503213	83503213
19	ROLLER BEARING	83503231	83503231
20	GEAR, 1st	83503214 (12x34T)	83505444 (12X32T)
21	SHIM	83504622	83504622
22	SHIM SET	83503222	83503222
23	RING, retaining	83505477	83505477
24	NUT	83503204	83503204
25	RING, locking	83503253	83503253
26	GEAR, 5th	83504099 (53x27T)	83505452 (51x28T)
27	BEARING	83503249	83503249
28	RING, retaining	83503224	83503224
29	BEARING	83503209 (4)	83503209 (4)
30	SHIM SET	83503254	83503254
31	GEAR, cluster	83503239 (5)	83503239 (5)
32	BEARING	83503209	83503209
33	RING, retaining		83505478
34	GEAR, 5th intermediate	83503242	83503242
35	SYNCHRONIZER, 5th gear	83503246	83503246
36	BEARING	83503207	83503207
37	GEAR, 5th intermediate	83503243 (53x27T)	83505451 (51x28T)
38	SHIM	83503247	83503247
39	SHIM SET	83503237	83503237
40	BEARING	83503201	83503201
41	CASE	83505274	83505446

- NOTE:** (1). With 2WD use 83504429.
 (2). Used with 2WD.
 (3). For XJ, 1987, use 83503229.
 For YJ, thru Trans. I.D. #71787, use 83503229.
 (4). 1987 only. For 1988-90 use 83504447.
 (5). For XJ, thru Trans. I.D. #131162, use 83503239.
 For XJ, Trans. I.D. #131163-Up, use 83505445.
 For YJ, thru Trans. I.D. #131000, use 83503239.
 For YJ, Trans. I.D. #131001-Up, use 83505445.

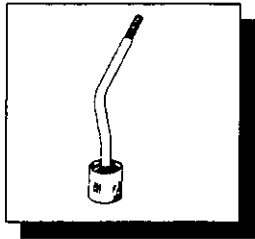

LEVER, Floor Gear Shift

7.001

6 Cyl : SJ, 1979 use J8128779 (T18)
 6 Cyl : SJ, 1980 use J5359837 (T176)
 6 Cyl : SJ, 1981-86 use J5359835 (T176)
 6 Cyl : SJ, 1987-90 use J5359837 (T177)

8 Cyl : SJ, 1979 use J8128779 (T18)
 8 Cyl : SJ, 1980 use J5359835 (T178)
 8 Cyl : J20, 1980-86 use J8132660 (T18)
 8 Cyl : SJ, 1981-86 use J5359835 (T176)
 8 Cyl : SJ, 1987-90 use J5359837 (T177)

4 Cyl : XJ, 1984-85 use 83510058 (T4, T5)
 4 Cyl : XJ, 1984-90 use 83500518 (AX4, AX5)
 V6 Cyl : XJ, 1984-86 use 83510058 (T4, T5)
 V6 Cyl : XJ, 1984-86 use 83500518 (AX4, AX5)
 I6 Cyl : XJ, 1987-89 use 83504113 (BA10/5)
 I6 Cyl : XJ, 1989-90 use 5252042 (AX-15)

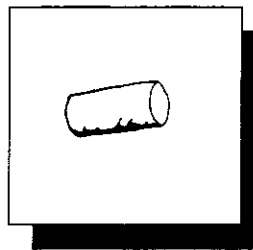

PIN, Floor Gear Shift Lever Fulcrum

7.001

6 Cyl : SJ, 1979 use J0912374 (T18)
 6 Cyl : SJ, 1980-90 use J8132407 (T176, T177)
 8 Cyl : SJ, 1979 use J0912374 (T18)
 8 Cyl : SJ, 1980-90 use J8132407 (T176, 177, 178)



RETAINER, Floor Gear Shift Lever Fulcrum Spring

7.001

6 Cyl : SJ, 1979 use J0912379 (T18)
 6 Cyl : SJ, 1980-90 use J8132420 (T176, T177)
 8 Cyl : SJ, 1979 use J0912379 (T18)
 8 Cyl : SJ, 1980-90 use J8132420 (T176, 177, 178)

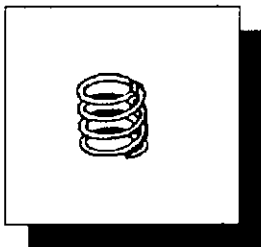

SPRING, Floor Gear Shift Lever Fulcrum

7.001

6 Cyl : SJ, 1979 use J0801732 (T18)
 6 Cyl : SJ, 1980-89 use J8127059 (T176, T177)

8 Cyl : SJ, 1979 use J0801732 (T18)
 8 Cyl : SJ, 1980-89 use J8127059 (T176, T177, T178)

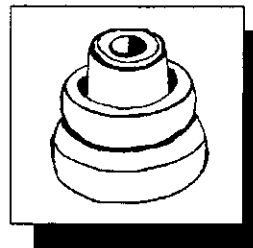

COVER, Floor Gear Shift Lever

7.013

6 Cyl : SJ, 1980-90 use J8132422 (T176, T177)
 8 Cyl : SJ, 1980-90 use J8132422 (T176, T177, T178)

4 Cyl : XJ, 1984-85 use J8134064 (T4, T5)
 4 Cyl : XJ, 1984-90 use 83500520 (AX4, AX5)
 V6 Cyl : XJ, 1984-86 use J8134064 (T4, T5)
 V6 Cyl : XJ, 1984-86 use 83500520 (AX4, AX5)
 I6 Cyl : XJ, 1987-89 use 83504621 (BA10/5)
 I6 Cyl : XJ, 1989-90 use 83500520 (AX-15)



BOOT, Floor Gear Shift Lever - Outer

4 Cyl : XJ, 1984-90 use 53004433
 V6 Cyl : XJ, 1984-86 use 53000055
 16 Cyl : XJ, 1987-90 use 53004433

7.013

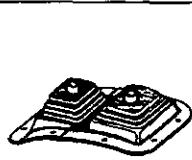

**BOOT, Transmission & Transfer Case
 Shift Lever - Black**

6 Cyl : SJ, 1980-90 use J5752011
 8 Cyl : SJ, 1980-90 use J5752011

7.013



CAP, Transmission Control Housing

7.013

6 Cyl : SJ, 1979 use J0912380 (T18)
 6 Cyl : SJ, 1980-90 use J8134667 (T176, T177)
 8 Cyl : SJ, 1979 use J0912380 (T18)
 8 Cyl : SJ, 1980-90 use J8134667 (T176, T177, T178)

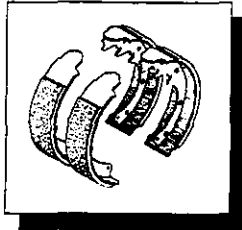

8.004

SHOE SET, Rear Brake

6 Cyl : SJ, 1979-90 use J8127782 ¹
 8 Cyl : SJ, 1979-90 use J8127782 ¹

4 Cyl : XJ, 1984-89 use J8133818 ²
 4 Cyl : XJ, 1990 use J4423606 ²
 V6 Cyl : XJ, 1984-86 use J8133818 ²
 I6 Cyl : XJ, 1987-89 use J8133818 ²
 I6 Cyl : XJ, 1990 use J4423606 ²
 Diesel : XJ, 1984-89 use J8133818 ²
 Diesel : XJ, 1990 use J4423606 ²

NOTE: 1. FOR J20, MODEL 60 AXLE USE J8130362.
 2. USED WITH AMC & DANA MODEL 35 AXLE. WITH DANA MODEL 44 AXLE USE 83502385.

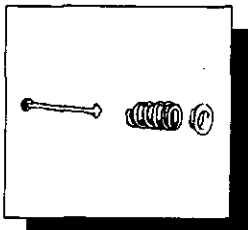

8.004

HOLD DOWN AND SPRING KIT, Brake Shoe (with Pin, Springs, Clip and Cables)

6 Cyl : SJ, 1979-89 use 4636775 ¹
 8 Cyl : SJ, 1979-89 use 4636775 ¹

4 Cyl : XJ, 1985-89 use 4636777 ²
 4 Cyl : XJ, 1990 use 4636779 ²
 V6 Cyl : XJ, 1985-86 use 4636777 ²
 I6 Cyl : XJ, 1987-89 use 4636777 ²
 I6 Cyl : XJ, 1990 use 4636779 ²
 Diesel : XJ, 1985-89 use 4636777 ²
 Diesel : XJ, 1990 use 4636779 ²

NOTE: 1. FOR J20, MODEL 60 AXLE USE J8124526.
 2. WITH DANA MODEL 44 AXLE USE 4636778.

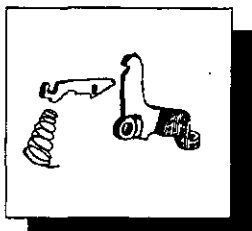

8.013

ADJUSTER KIT, Brake Automatic - Left

6 Cyl : SJ, 1979-90 use J8124513 ¹
 8 Cyl : SJ, 1979-90 use J8124513 ¹

NOTE: 1. FOR J20, MODEL 60 AXLE USE J8124524.

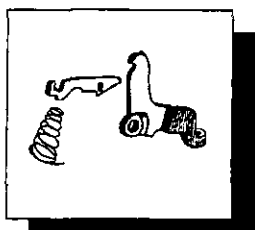

8.013

ADJUSTER KIT, Brake Automatic - Right

6 Cyl : SJ, 1979-90 use J8124514 ¹
 8 Cyl : SJ, 1979-90 use J8124514 ¹

NOTE: 1. FOR J20, MODEL 60 AXLE USE J8124525.

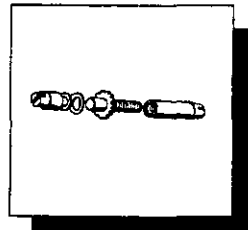

8.014

SCREW KIT, Brake Adjusting - Left

6 Cyl : SJ, 1979-89 use J8127785 ¹
 8 Cyl : SJ, 1979-89 use J8127785 ¹

4 Cyl : XJ, 1984-89 use 52001215 ²
 V6 Cyl : XJ, 1984-87 use 52001215 ²
 I6 Cyl : XJ, 1986-89 use 52001215 ²
 Diesel : XJ, 1984-89 use 52001215 ²

NOTE: 1. FOR J20, MODEL 60 AXLE USE J8124528.
 2. WITH MODEL 44 AXLE USE 83504309.

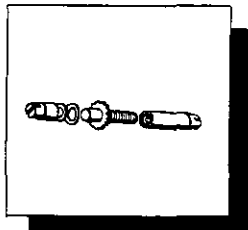

8.014

SCREW KIT, Brake Adjusting - Right

6 Cyl : SJ, 1979-89 use J8127786 ¹
 8 Cyl : SJ, 1979-89 use J8127786 ¹

4 Cyl : XJ, 1984-89 use 52001216 ²
 V6 Cyl : XJ, 1984-87 use 52001216 ²
 I6 Cyl : XJ, 1986-89 use 52001216 ²
 Diesel : XJ, 1984-89 use 52001216 ²

NOTE: 1. FOR J20, MODEL 60 AXLE USE J8124529.
 2. WITH MODEL 44 AXLE USE 83504308.

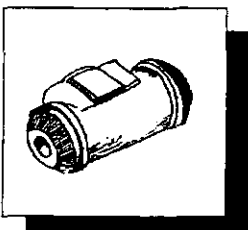

8.068

CYLINDER ASSY, Rear Brake

6 Cyl : SJ, 1979-89 use J8129723 ¹
 8 Cyl : SJ, 1979-89 use J8129723 ¹

LEFT

4 Cyl : XJ, 1984-89 use 52000849
 V6 Cyl : XJ, 1984-87 use 52000849
 I6 Cyl : XJ, 1986-89 use 52000849
 Diesel : XJ, 1984-89 use 52000849

RIGHT

4 Cyl : XJ, 1984-89 use 52000848
 V6 Cyl : XJ, 1984-87 use 52000848
 I6 Cyl : XJ, 1986-89 use 52000848
 Diesel : XJ, 1984-89 use 52000848

L & R

4 Cyl : XJ, 1990 use 4313056
 V6 Cyl : XJ, 1990 use 4313056
 I6 Cyl : XJ, 1990 use 4313056
 Diesel : XJ, 1990 use 4313056

NOTE: 1. FOR J20, MODEL 60 AXLE USE J8129724.

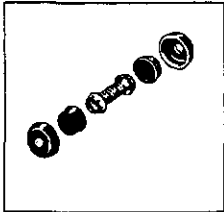

8.080

REPAIR KIT, Rear Wheel Cylinder

6 Cyl : SJ, 1979-90 use J8124566 1
8 Cyl : SJ, 1979-90 use J8124566 1

4 Cyl : XJ, 1984-89 use 83500987
4 Cyl : XJ, 1990 use J5252531
V6 Cyl : XJ, 1984-86 use 83500987
I6 Cyl : XJ, 1987-89 use 83500987
I6 Cyl : XJ, 1990 use J5252531
Diesel : XJ, 1984-89 use 83500987
Diesel : XJ, 1990 use J5252531

NOTE: 1. FOR J20, MODEL 60 AXLE USE J8128856.

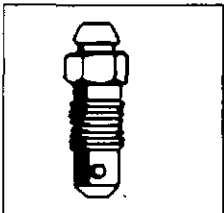

8.088

SCREW, Brake Wheel Cylinder Bleeder

6 Cyl : SJ, 1979-90 use J8129725
8 Cyl : SJ, 1979-90 use J8129725

4 Cyl : XJ, 1984-89 use J3203313
4 Cyl : XJ, 1990 use J3766674
V6 Cyl : XJ, 1984-86 use J3203313
I6 Cyl : XJ, 1987-89 use J3203313
I6 Cyl : XJ, 1990 use J3766674
Diesel : XJ, 1984-89 use J3203313
Diesel : XJ, 1990 use J3766674

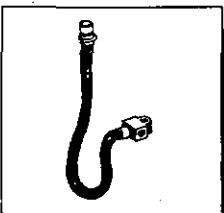

8.116

HOSE, Brake Tube (Rear Axle)

6 Cyl : SJ, 1979-89 use J5355076 1
8 Cyl : SJ, 1979-89 use J5355076 1

4 Cyl : XJ, 1984-89 use 52000162
4 Cyl : XJ, 1990 use 52005045
V6 Cyl : XJ, 1984-86 use 52000162
I6 Cyl : XJ, 1987-89 use 52000162
I6 Cyl : XJ, 1990 use 52005045

NOTE: 1. FOR J20, MODEL 60 AXLE, USE J5355073. FOR J10, WITH 131" WHEELBASE USE J5355073.

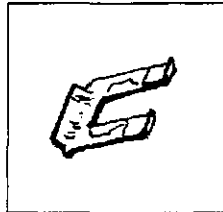

8.116

CLIP, Brake Tube Fastening

6 Cyl : SJ, 1979-89 use J0637427
8 Cyl : SJ, 1979-89 use J0637427

4 Cyl : XJ, 1984-90 use J047774
V6 Cyl : XJ, 1984-86 use J047774
I6 Cyl : XJ, 1987-90 use J047774
Diesel : XJ, 1984-90 use J047774

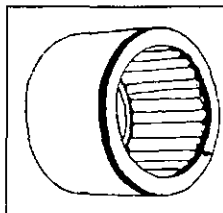

8.140

BUSHING, Brake Pedal

6 Cyl : SJ, 1979-90 use J0946177
8 Cyl : SJ, 1979-90 use J0946177

4 Cyl : XJ, 1984-90 use J3225981
V6 Cyl : XJ, 1984-86 use J3225981
I6 Cyl : XJ, 1987-90 use J3225981
Diesel : XJ, 1984-90 use J3225981

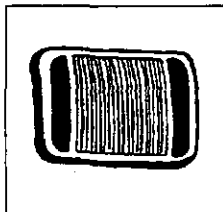

8.148

PAD, Brake Pedal with Manual Transmission

6 Cyl : SJ, 1979-90 use J5363508
8 Cyl : SJ, 1979-90 use J5363508

4 Cyl : XJ, 1984-90 use 52002750
V6 Cyl : XJ, 1984-86 use 52002750
I6 Cyl : XJ, 1987-90 use 52002750
Diesel : XJ, 1984-90 use 52002750

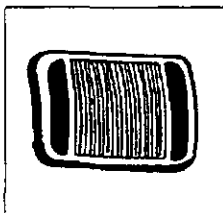

8.148

PAD, Brake Pedal with Automatic Transmission

6 Cyl : SJ, 1979-81 use J5357428
6 Cyl : SJ, 1982-90 use J5363521
8 Cyl : SJ, 1979-81 use J5357428
8 Cyl : SJ, 1982-90 use J5363521

4 Cyl : XJ, 1984-85 use J3212262
4 Cyl : XJ, 1986-90 use 52002749
V6 Cyl : XJ, 1984-85 use J3212262
V6 Cyl : XJ, 1986 use 52002749
I6 Cyl : XJ, 1987-90 use 52002749
Diesel : XJ, 1984-85 use J3212262
Diesel : XJ, 1986-90 use 52002749

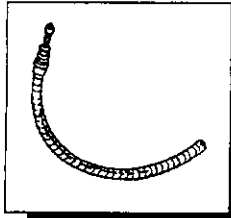

8.192

CABLE, Foot Operated Parking Brake to Equalizer

4 Speed - (Front)

- 6 Cyl : SJ, 1979 use J5355722
- 6 Cyl : SJ, 1980-90 use J5361026
- 8 Cyl : SJ, 1979 use J5355722
- 8 Cyl : SJ, 1980-90 use J5361026

NOTE: 1. FOR J20 USE J5361029.

5 Speed & Automatic - (Front)

- 6 Cyl : SJ, 1979 use J5356189
- 6 Cyl : SJ, 1980-90 use J5361029
- 8 Cyl : SJ, 1979 use J5355722
- 8 Cyl : SJ, 1980-90 use J5361029

- 4 Cyl : MJ, 1986 use 52000802
- 4 Cyl : MJ, 1987-90 use 52003192; w/ 6' Box
- 4 Cyl : MJ, 1987-90 use 52003190; w/ 7' Box
- V6 Cyl : MJ, 1986 use 52000802
- I6 Cyl : MJ, 1987-90 use 52003192; w/ 6' Box
- I6 Cyl : MJ, 1987-90 use 52003190; w/ 7' Box

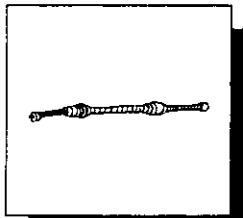

8.220

CABLE, to Rear Wheels

- 6 Cyl : SJ, 1979 use J5357412
- 6 Cyl : SJ, 1980-90 use J5362132
- 6 Cyl : SJ, J10 use J5362131 (w/ 119" w.b.)
- 6 Cyl : SJ, J10 use J5362130 (w/ 131" w.b.)
- 6 Cyl : SJ, J20 use J5362136 (w/ 119" w.b.)

- 8 Cyl : SJ, 1979 use J5357412
- 8 Cyl : SJ, 1980-90 use J5362132
- 8 Cyl : SJ, J10 use J5362131 (w/ 119" w.b.)
- 8 Cyl : SJ, J10 use J5362130 (w/ 131" w.b.)
- 8 Cyl : SJ, J20 use J5362136 (w/ 119" w.b.)

- 4 Cyl : XJ, 1984-86 use 52001153
- 4 Cyl : XJ, 1987-89 use 52003256
- 4 Cyl : XJ, 1990 use 52004709



8.215

CABLE, Equalizer to Rear Cable

- V6 Cyl : XJ, 1984-86 use 52001153
- V6 Cyl : MJ, 1986 use 52000865
- I6 Cyl : XJ, 1987-89 use 52003256
- I6 Cyl : XJ, 1990 use 52004709
- I6 Cyl : MJ, 1987-89 use 52003188
- I6 Cyl : MJ, 1990 use 52004708

- Diesel : XJ, 1984-86 use 52001153
- Diesel : XJ, 1987-89 use 52003256
- Diesel : XJ, 1990 use 42004709

MANUAL

- 6 Cyl : SJ, 1979 use J5355330 (60-1/8")
- 6 Cyl : SJ, 1980-90 use J5361279
- 6 Cyl : SJ, 1982-86 use J5363681 (w/ 5 Spd)

- 8 Cyl : SJ, 1979 use J5355330 (60-1/8")
- 8 Cyl : SJ, 1979 use J5355334 (85-1/4")
- 8 Cyl : SJ, 1980 use J5361280 (J20)
- 8 Cyl : SJ, 1980-90 use J5361279
- 8 Cyl : SJ, 1981-90 use J5362868 (J20)
- 8 Cyl : SJ, 1982-86 use J5363681 (w/ 5 Spd)

AUTOMATIC

- 6 Cyl : SJ, 1979 use J5359431 (60")
- 6 Cyl : SJ, 1979 use J5359432 (80-5/8")
- 6 Cyl : SJ, 1980-90 use J5361280

- 8 Cyl : SJ, 1979 use J5355329 (64-5/8")
- 8 Cyl : SJ, 1979 use J5355334 (85-1/4")
- 8 Cyl : SJ, 1980-90 use J5361279

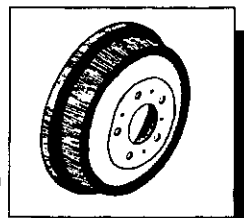

8.245

DRUM, Rear Brake

- 6 Cyl : SJ, 1979-89 use J5359281
- 8 Cyl : SJ, 1979-89 use J5359281

- 4 Cyl : XJ, 1984-89 use 52001151²
- 4 Cyl : XJ, 1990 use 52005350²
- V6 Cyl : XJ, 1984-86 use 52001151²
- I6 Cyl : XJ, 1987-89 use 52001151²
- I6 Cyl : XJ, 1990 use 52005350²
- Diesel : XJ, 1984-89 use 52001151²

NOTE: 1. FOR J20 USE J8124957.
2. FROM 1986-90, WITH DANA MODEL 44 AXLE USE 52001915.

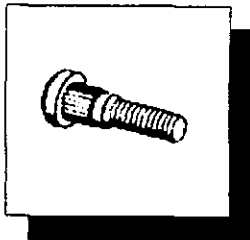

8.247

BOLT, Wheel

6 Cyl : SJ, 1979-89 use J3230413 ¹
 8 Cyl : SJ, 1979-89 use J3230413 ¹

4 Cyl : XJ, 1984-90 use 83503053 ²
 V6 Cyl : XJ, 1984-86 use 83503053 ²
 I6 Cyl : XJ, 1987-90 use 83503053 ²
 Diesel : XJ, 1984-90 use 83503053 ²

NOTE: 1. FOR J20 USE J8124958.
 2. FOR DANA 44 AXLE, 1986-87, USE
 J3220275.



8.294

CUP, Front Wheel Inner

6 Cyl : SJ, 1979-89 use J5357394 ¹
 8 Cyl : SJ, 1979-89 use J5357394 ¹

NOTE: 1. FOR J20 USE J8124840.

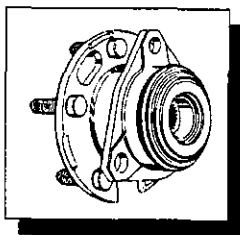

8.286

HUB ASSY, Front Wheel

4 Cyl : XJ, 1984-89 use 53000228
 4 Cyl : XJ, 1990 use 53005604
 V6 Cyl : XJ, 1984-86 use 53000228
 I6 Cyl : XJ, 1987-89 use 53000228
 I6 Cyl : XJ, 1990 use 53005604
 Diesel : XJ, 1984-89 use 53000228
 Diesel : XJ, 1990 use 53005604



8.294

CUP, Front Wheel Outer

6 Cyl : SJ, 1979-89 use J0925447 ¹
 8 Cyl : SJ, 1979-89 use J0925447 ¹

NOTE: 1. FOR J20 USE J0992336.



8.292

BEARING, Front Wheel Inner

6 Cyl : SJ, 1979-90 use J5357401 ²
 8 Cyl : SJ, 1979-90 use J5357401 ²

4 Cyl : XJ, 1984-90 use 53000238 ¹
 V6 Cyl : XJ, 1984-86 use 53000238 ¹
 I6 Cyl : XJ, 1987-90 use 53000238 ¹
 Diesel : XJ, 1984-90 use 53000238 ¹

NOTE: 1. BEARING ASSY, INC. CUP + CONE.
 2. FOR J20 USE J5352661.

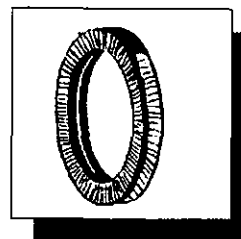

8.296

RETAINER, Front Wheel Grease (Seal)

6 Cyl : SJ, 1979-90 use J5359703 ¹
 8 Cyl : SJ, 1979-90 use J5359703 ¹

INNER

4 Cyl : XJ, 1984-90 use 53000239
 V6 Cyl : XJ, 1984-86 use 53000239
 I6 Cyl : XJ, 1987-90 use 53000239
 Diesel : XJ, 1984-90 use 53000239

OUTER

4 Cyl : XJ, 1984-90 use J3238137
 V6 Cyl : XJ, 1984-86 use J3238137
 I6 Cyl : XJ, 1987-90 use J3238137
 Diesel : XJ, 1984-90 use J3238137

NOTE: 1. FOR J20, 1979-80, USE J5352637.
 FOR 1981-90 USE J5352786.



8.292

BEARING, Front Wheel Outer

6 Cyl : SJ, 1979-90 use J3156052 ²
 8 Cyl : SJ, 1979-90 use J3156052 ²

4 Cyl : XJ, 1984-90 use 53000238 ¹
 V6 Cyl : XJ, 1984-86 use 53000238 ¹
 I6 Cyl : XJ, 1987-90 use 53000238 ¹
 Diesel : XJ, 1984-90 use 53000238 ¹

NOTE: 1. BEARING ASSY, INC. CUP + CONE.
 2. FOR J20 USE J0992276.



CAP, Front Wheel Grease Outer

6 Cyl : SJ, 1979-90 use J5352268 1
8 Cyl : SJ, 1979-90 use J5352268 1

NOTE: 1. FOR J20 USE J0947085

8.296

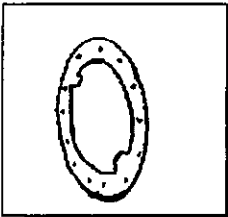

WASHER, Front Wheel Bearing Lock

6 Cyl : SJ, 1979-90 use J4004815 1
8 Cyl : SJ, 1979-90 use J4004815 1

NOTE: 1. FOR J20 USE J4004829, FRONT + REAR.

8.296

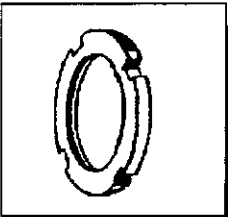

NUT, Front Wheel Bearing Retainer - Inner

6 Cyl : SJ, 1979-90 use J4004816 1
8 Cyl : SJ, 1979-90 use J4004816 1

NOTE: 1. FOR J20 USE J0992300, FRONT + REAR.

8.296

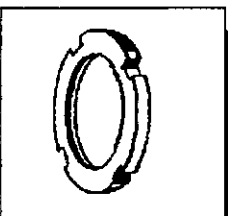

NUT, Front Wheel Bearing Retainer - Outer

6 Cyl : SJ, 1979-90 use J5352169 1
8 Cyl : SJ, 1979-90 use J5352169 1

NOTE: 1. FOR J20 USE J0992300, FRONT + REAR.

8.296

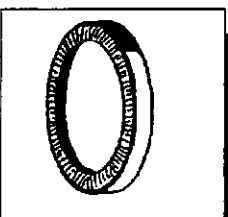

CUP, Front Wheel Retainer Spring

6 Cyl : SJ, 1979-90 use J5352650
8 Cyl : SJ, 1979-90 use J5352650

8.296



BEARING, Rear Wheel

6 Cyl : SJ, 1979-90 use J3230115 1
8 Cyl : SJ, 1979-90 use J3230115 1

4 Cyl : XJ, 1984-90 use 53000475 2
V6 Cyl : XJ, 1984-86 use 53000475 2
I6 Cyl : XJ, 1987 use 53000475 2
Diesel : XJ, 1984-90 use 53000475 2

8.300

NOTE: 1. FOR J20 USE J5352661 FOR INNER AND J0992276 FOR OUTER.
2. WITH DANA MODEL 44 USE 83503064.



BEARING KIT, Includes Bearings, Seals & Retainers

6 Cyl : SJ, 1979-85 use J8130510 1
8 Cyl : SJ, 1979-85 use J8130510 1

8.300

4 Cyl : XJ, 1984-87 use 83500141
V6 Cyl : XJ, 1984-86 use 83500141
I6 Cyl : XJ, 1987 use 83500141
Diesel : XJ, 1984-87 use 83500141

NOTE: 1. NOT INCLUDING J20.



CUP, Rear Wheel Bearing - J20 Only

6 Cyl : SJ, 1979-90 use J8124840 1
8 Cyl : SJ, 1979-90 use J8124840 1

8.302

NOTE: 1. FOR OUTER USE J0992336.

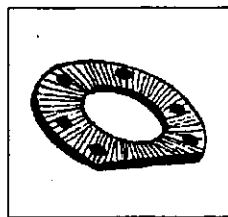

RETAINER, Rear Wheel Bearing

6 Cyl : SJ, 1979-90 use J3239073 1
8 Cyl : SJ, 1979-90 use J3239073 1

8.303

4 Cyl : XJ, 1984-90 use 83503022
V6 Cyl : XJ, 1984-86 use 83503022
I6 Cyl : XJ, 1987-90 use 83503022 2
Diesel : XJ, 1984-90 use 83503022

NOTE: 1. NOT INCLUDING J20.
2. WITH DANA MODEL 44 USE 83504190.

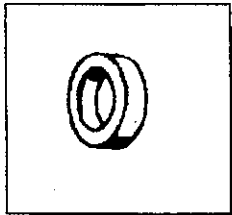

8.303

RING, Rear Axle Bearing Retaining

6 Cyl : SJ, 1979 use J3239074 ¹
 6 Cyl : SJ, 1980 use J3230151 ¹
 6 Cyl : SJ, 1981-86 use J3239074 ¹
 6 Cyl : SJ, 1987-90 use 83503077
 8 Cyl : SJ, 1979 use J3239074 ¹
 8 Cyl : SJ, 1980 use J3230151 ¹
 8 Cyl : SJ, 1981-86 use J3239074 ¹
 8 Cyl : SJ, 1987-90 use 83503077

4 Cyl : XJ, 1984-85 use 53002527 ²
 4 Cyl : XJ, 1986-90 use 83503054 ²
 V6 Cyl : XJ, 1984-85 use 53002527 ²
 V6 Cyl : XJ, 1986 use 83503054 ²
 I6 Cyl : XJ, 1987-90 use 83503054 ²
 Diesel : XJ, 1984-85 use 53002527 ²
 Diesel : XJ, 1986-90 use 83503054 ²

NOTE: 1. NOT INCLUDING J20.
 2. WITH DANA MODEL 44 USE 83503077.

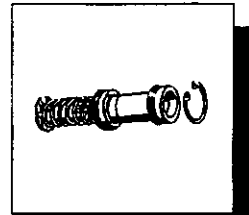

8.512

REPAIR KIT, Power Brake Master Cylinder

6 Cyl : SJ, 1979-80 use J8127771
 6 Cyl : SJ, 1981-90 use J8133317
 8 Cyl : SJ, 1979-80 use J8127771
 8 Cyl : SJ, 1981-90 use J8133317

4 Cyl : XJ, 1984-89 use 83510015
 4 Cyl : XJ, 1990 use 5252625
 V6 Cyl : XJ, 1984-86 use 83510015
 I6 Cyl : XJ, 1987-89 use 83510015
 I6 Cyl : XJ, 1990 use 5252625
 Diesel : XJ, 1984-89 use 83510015
 Diesel : XJ, 1990 use 5252625

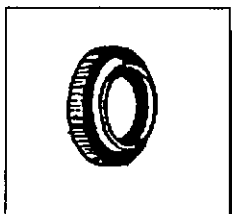

8.303

SEAL, Rear Axle Bearing

6 Cyl : SJ, 1979-80 use J0994261 ¹
 6 Cyl : SJ, 1981-90 use J3240086 ¹
 8 Cyl : SJ, 1979-80 use J0994261 ¹
 8 Cyl : SJ, 1981-90 use J3240086 ¹

4 Cyl : XJ, 1984-90 use 53000477 ²
 V6 Cyl : XJ, 1984-86 use 53000477 ²
 I6 Cyl : XJ, 1987-90 use 53000477 ²
 Diesel : XJ, 1984-90 use 53000477 ²

NOTE: 1. FOR J20 USE J5352786.
 2. WITH DANA MODEL 44 USE 83503063.

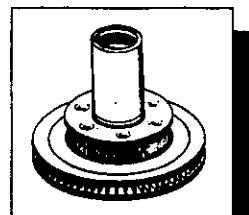

8.805

DISC ASSY, Front Wheel Brake

6 Cyl : SJ, 1979-80 use J5357391 ¹
 8 Cyl : SJ, 1979-89 use J5357391 ¹

4 Cyl : XJ, 1984-89 use J3251156
 4 Cyl : XJ, 1990 use 52005000
 V6 Cyl : XJ, 1984-86 use J3251156
 I6 Cyl : XJ, 1987-89 use J3251156
 I6 Cyl : XJ, 1990 use 52005000
 Diesel : XJ, 1984-89 use J3251156
 Diesel : XJ, 1990 use 52005000

NOTE: 1. FOR J20 USE J5359275.

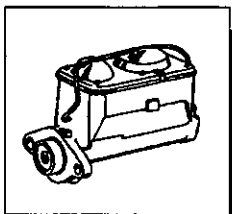

8.510

CYLINDER ASSY, Power Brake Master

6 Cyl : SJ, 1979-80 use J8129731
 6 Cyl : SJ, 1981-89 use J8133316
 6 Cyl : SJ, 1979-80 use J8129731
 6 Cyl : SJ, 1981-89 use J8133316

4 Cyl : XJ, 1984-89 use J3241807
 4 Cyl : XJ, 1990 use 5252622
 V6 Cyl : XJ, 1984-86 use J3241807
 I6 Cyl : XJ, 1987-89 use J3241807
 I6 Cyl : XJ, 1990 use 5252622
 Diesel : XJ, 1986-89 use J3241807
 Diesel : XJ, 1990 use 5252622

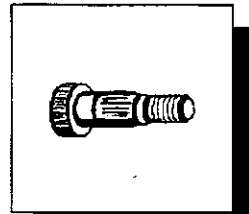

8.805

STUD, Front Wheel Disc Brake Disc Assy to Wheel

6 Cyl : SJ, 1979-89 use J8124803 ¹
 8 Cyl : SJ, 1979-89 use J8124803 ¹

4 Cyl : XJ, 1984-89 use J3238138
 4 Cyl : XJ, 1990 use 53007463
 V6 Cyl : XJ, 1984-86 use J3238138
 I6 Cyl : XJ, 1987-89 use J3238138
 I6 Cyl : XJ, 1990 use 53007463
 Diesel : XJ, 1984-89 use J3238138
 Diesel : XJ, 1990 use 53007463

NOTE: 1. FOR J20 USE J5359276.

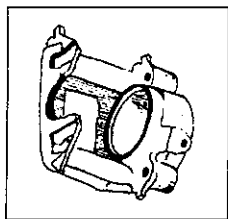

8.810

CALIPER ASSY, Front Wheel Disc Brake - Left

6 Cyl : SJ, 1979-85 use J8133311
 6 Cyl : SJ, 1986-90 use 83501981
 8 Cyl : SJ, 1979-85 use J8133311
 8 Cyl : SJ, 1986-90 use 83501981

4 Cyl : XJ, 1984-89 use J8133847
 4 Cyl : XJ, 1990 use 5252610
 V6 Cyl : XJ, 1984-86 use J8133847
 I6 Cyl : XJ, 1987-89 use J8133847
 I6 Cyl : XJ, 1990 use 5252610
 Diesel : XJ, 1984-89 use J8133847
 Diesel : XJ, 1990 use 5252610

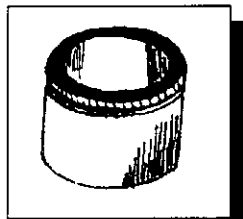

8.810

PISTON, Disc Brake Caliper

6 Cyl : SJ, 1979-89 use J8124571
 8 Cyl : SJ, 1979-89 use J8124571

4 Cyl : XJ, 1984-89 use J8133845 1
 4 Cyl : XJ, 1990 use 5252614 1
 V6 Cyl : XJ, 1984-86 use J8133845 1
 I6 Cyl : XJ, 1987-89 use J8133845 1
 I6 Cyl : XJ, 1990 use 5252614 1
 Diesel : XJ, 1984-89 use J8133845 1
 Diesel : XJ, 1990 use 5252614 1

NOTE: 1. INCLUDES SEALS.

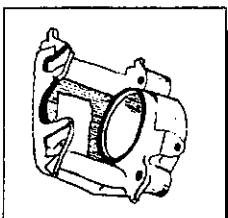

8.810

CALIPER ASSY, Front Wheel Disc Brake - Right

6 Cyl : SJ, 1979-85 use J8133312
 6 Cyl : SJ, 1986-90 use 83501980
 8 Cyl : SJ, 1979-85 use J8133312
 8 Cyl : SJ, 1986-90 use 83501980

4 Cyl : XJ, 1984-89 use J8133846
 4 Cyl : XJ, 1990 use 5252609
 V6 Cyl : XJ, 1984-86 use J8133846
 I6 Cyl : XJ, 1987-89 use J8133846
 I6 Cyl : XJ, 1990 use 5252609
 Diesel : XJ, 1984-89 use J8133846
 Diesel : XJ, 1990 use 5252609

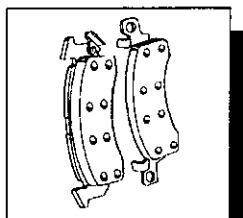

8.815

SHOE SET, Front Wheel Disc Brake (Pad Set)

6 Cyl : SJ, 1979-90 use 83504371
 8 Cyl : SJ, 1979-90 use 83504371

4 Cyl : XJ, 1984-89 use 83501167
 4 Cyl : XJ, 1990 use 5252531
 V6 Cyl : XJ, 1984-86 use 83501167
 I6 Cyl : XJ, 1987-89 use 83501167
 I6 Cyl : XJ, 1990 use 5252531
 Diesel : XJ, 1984-89 use 83501167
 Diesel : XJ, 1990 use 5252531

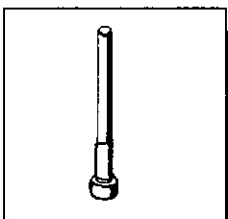

8.810

BOLT, Housing Retainer

6 Cyl : SJ, 1979-89 use J8124572
 8 Cyl : SJ, 1979-89 use J8124572

4 Cyl : XJ, 1984-89 use 83504655 1
 4 Cyl : XJ, 1990 use 5253000 2
 V6 Cyl : XJ, 1984-86 use 83504655 1
 I6 Cyl : XJ, 1987-89 use 83504655 1
 I6 Cyl : XJ, 1990 use 5253000 2
 Diesel : XJ, 1984-89 use 83504655 1
 Diesel : XJ, 1990 use 5253000 2

NOTE: 1. USE WITH 52001700 BUSHING AND 52001701 SLEEVE.
 2. USE WITH 4383471 BUSHING AND 4636017 SLEEVE.

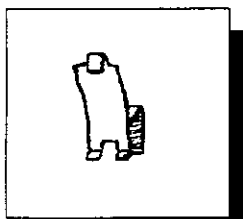

8.815

SPRING, Shoe Support (Clip Type)

6 Cyl : SJ, 1979-89 use J8124573
 8 Cyl : SJ, 1979-89 use J8124573

4 Cyl : XJ, 1984-90 use J3239865
 V6 Cyl : XJ, 1984-86 use J3239865
 I6 Cyl : XJ, 1987-90 use J3239865
 Diesel : XJ, 1984-90 use J3239865

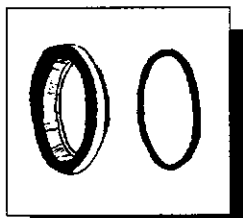

8.820

REPAIR KIT, Disc Brake Piston Housing (Boot & Seal)

6 Cyl : SJ, 1979-90 use J8124574
 8 Cyl : SJ, 1979-90 use J8124574

4 Cyl : XJ, 1984-90 use J8133852
 V6 Cyl : XJ, 1984-86 use J8133852
 I6 Cyl : XJ, 1987-90 use J8133852
 Diesel : XJ, 1984-90 use J8133852

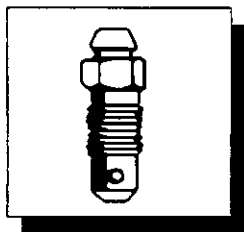

8.830

BLEEDER SCREW, Caliper

6 Cyl : SJ, 1979-89 use J8129722
 8 Cyl : SJ, 1979-89 use J8129722

4 Cyl : XJ, 1984-90 use J3203313
 V6 Cyl : XJ, 1984-86 use J3203313
 I6 Cyl : XJ, 1987-90 use J3203313
 Diesel : XJ, 1984-90 use J3203313



8.855

HOSE, Front Wheel Disc Brake

6 Cyl : SJ, 1979-89 use J5359322
 8 Cyl : SJ, 1980-89 use J5359322

LEFT

4 Cyl : XJ, 1984-89 use 52001405
 4 Cyl : XJ, 1990 use 52006471
 V6 Cyl : XJ, 1984-86 use 52001405
 I6 Cyl : XJ, 1987-89 use 52001405
 I6 Cyl : XJ, 1990 use 52006471
 Diesel : XJ, 1984-89 use 52001405
 Diesel : XJ, 1990 use 52006471

RIGHT

4 Cyl : XJ, 1984-89 use 52001404
 4 Cyl : XJ, 1990 use 52006470
 V6 Cyl : XJ, 1984-86 use 52001404
 I6 Cyl : XJ, 1987-89 use 52001404
 I6 Cyl : XJ, 1990 use 52006470
 Diesel : XJ, 1984-89 use 52001404
 Diesel : XJ, 1990 use 52006470

NOTE: 1. FOR J20 USE J5359323. FOR
 CHEROKEE CHIEF USE J5359323.

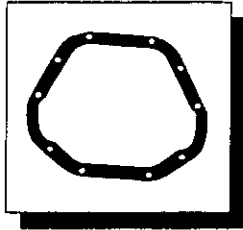

9.007

GASKET, Rear Axle Housing Cover

6 Cyl : SJ, 1979 use J8122409 1
 6 Cyl : SJ, 1980-86 use J3172122 2,3
 6 Cyl : SJ, 1987-90 use J8122409 1,3
 8 Cyl : SJ, 1979 use J8122409 1,3
 8 Cyl : SJ, 1980-86 use J3172122 2,3
 8 Cyl : SJ, 1987-90 use J8122409 1,3

NOTE: 1. WITH 10 BOLT COVER (DANA 44).
 2. WITH 12 BOLT COVER (AMC 20)
 3. J20, WITH DANA 60 USE J09433673.

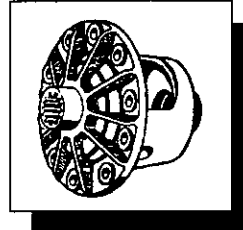

9.021

CASE ASSY, Rear Axle Differential W/ TRAC-LOC

2.73 Ratio, Model 44

6 Cyl : SJ, 1980 use J3236264
 8 Cyl : SJ, 1980 use J3236264

3.07, 3.08 Ratio, Model 35

ALL : XJ, 1984-89 use 83505020
 ALL : XJ, 1990 use 5252512

3.07, 3.54 Ratio, Model 44

ALL : SJ, 1979-90 use J8129218
 ALL : XJ, 1984-90 use J8129218

3.55, 4.11 Ratio, Model 35

ALL : XJ, 1984-89 use 83505021
 ALL : XJ, 1990 use 5252496

3.31, 4.10 Ratio, Model 44

6 Cyl : SJ, 1980-86 use J3230153
 8 Cyl : SJ, 1980-86 use J3230153

4.09 Ratio, Model 44

6 Cyl : SJ, 1979, 1986 use J8129232
 8 Cyl : SJ, 1979, 1986 use J8129232

3.54, 3.73 Ratio, Model 60, J20 only

6 Cyl : SJ, 1979-90 use J8129229
 8 Cyl : SJ, 1979-90 use J8129229

4.88 Ratio, Model 60, J20 only

6 Cyl : SJ, 1979-86 use J8129284
 8 Cyl : SJ, 1979-86 use J8129284

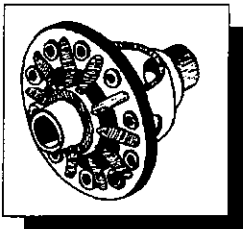

9.021

CASE ASSY, Rear Axle Differential STANDARD DIFFERENTIAL

2.73 Ratio, Model 20

6 Cyl : SJ, 1980-86 use J3235503
 8 Cyl : SJ, 1980-86 use J3235503

3.07 Ratio, Model 35

ALL : XJ, 1984-89 use 83502880
 ALL : XJ, 1990 use J5252510

3.07, 3.54 Ratio, Model 44

ALL : SJ, 1979 use J8129226
 ALL : SJ, 1986-90 use 83503073

ALL : XJ, 1984-90 use 83503073

3.31 Ratio, Model 20

6 Cyl : SJ, 1980-86 use J3235502
 8 Cyl : SJ, 1980-86 use J3235502

3.73 Ratio, Model 60, J20 only

6 Cyl : SJ, 1979-90 use J8129230
 8 Cyl : SJ, 1979-90 use J8129230

3.55, 4.11, 4.56 Ratio, Model 35

ALL : XJ, 1984-89 use 83503001
 ALL : XJ, 1990 use 5252494

4.09 Ratio, Model 44

6 Cyl : SJ, 1979 use J8124077
 6 Cyl : SJ, 1986-90 use 83503067
 8 Cyl : SJ, 1979 use J8124077
 8 Cyl : SJ, 1986-90 use 83503067

ALL : XJ, 1984-90 use 83503067

AXLE ASSEMBLIES

DANA MODEL 44 : 1979, 1986-90
 AMC MODEL 20 : 1980-85 (12 Bolt Cover)
 DANA MODEL 35 : 1984-90
 DANA MODEL 60 : 1979-90 (J20 Only)

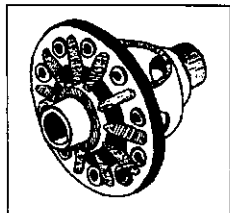

9.024

**CASE, Rear Axle Differential
STANDARD**

2.73 Ratio, Model 20
6 Cyl : SJ, 1980-85 use J3226978
8 Cyl : SJ, 1980-85 use J3226978

3.07, 3.54 Ratio, Model 44
6 Cyl : SJ, 1979 use J8129227
8 Cyl : SJ, 1979 use J8129227

3.31 Ratio, Model 20
6 Cyl : SJ, 1980-86 use J3212051
8 Cyl : SJ, 1980-86 use J3212051

3.73 Ratio, Model 60, J20 only
6 Cyl : SJ, 1979-90 use J8129238
8 Cyl : SJ, 1979-90 use J8129238

4.09 Ratio, Model 44
6 Cyl : SJ, 1979, 1986 use J8129245
8 Cyl : SJ, 1979, 1986 use J8129245

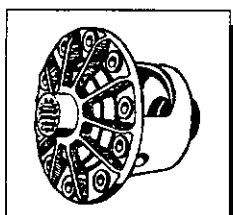

9.024

**CASE, Rear Axle Differential
TRAC-LOC**

3.07, 3.54 Ratio, Model 44
6 Cyl : SJ, 1979-90 use J8129219
8 Cyl : SJ, 1979-90 use J8129219

4.09 Ratio, Model 44
6 Cyl : SJ, 1979 use J8129233
8 Cyl : SJ, 1979 use J8129233

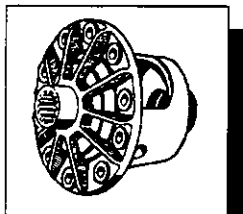

9.024

**CASE, Rear Axle Differential
TRAC-LOK**

**3.54, 3.73, 4.10 Ratio
Model 60, J20 only**
6 Cyl : SJ, 1979 use J8126075
6 Cyl : SJ, 1980-90 use J8130013
8 Cyl : SJ, 1979 use J8126075
8 Cyl : SJ, 1980-90 use J8130013

4.88 Ratio, Model 60, J20 only
6 Cyl : SJ, 1979-86 use J8124445
8 Cyl : SJ, 1979-86 use J8124445



9.027

**GEAR SET, Rear Axle Differential
STANDARD - Non-Locking**

ALL : SJ, 1979 use J8129228 ¹
ALL : SJ, 1979-86 use J8127092 ^{2,3}
ALL : SJ, 1986-90 use 83503068 ^{1,3}

ALL : XJ, 1984-89 use 83503002 ⁴
ALL : XJ, 1990 use 5252495 ⁴
ALL : XJ, 1984-90 use 83503068 ¹

NOTE:
1. W/ DANA 44 AXLE.
2. W/ AMC 20 AXLE.
3. W/ DANA 60 (J20), USE J8129241.
4. W/ DANA 35 AXLE.

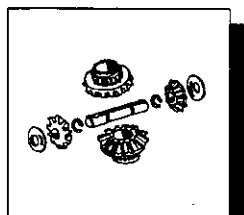

9.027

**GEAR SET, Rear Axle Differential
TRAC-LOK - Locking**

ALL : SJ, 1979 use J8129220 ^{1,3}
ALL : SJ, 1980-85 use J8120326 ^{2,3}
ALL : SJ, 1986-90 use J8129220 ^{3,5}

ALL : XJ, 1984-87 use 83500262 ⁴
ALL : XJ, 1988-89 use 83505022 ⁴
ALL : XJ, 1990 use J5252497 ⁴
ALL : XJ, 1984-90 use J8129220 ¹

NOTE:
1. W/ DANA 44 AXLE.
2. W/ AMC 20 AXLE.
3. W/ DANA 60 (J20), USE J8129240.
4. W/ DANA 35 AXLE.
5. IF CROSS SHAFT IS SECURED BY A ROLL PIN,
USE 83505432.

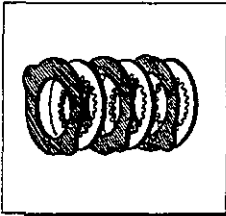

9.035

DISC KIT, Rear Axle Differential Clutch Friction (Trac-Lok)

ALL : SJ, 1979 use J0994345 ^{1,3}
 ALL : SJ, 1980-85 use J8120325 ^{2,3}
 ALL : SJ, 1986-89 use J0994345 ^{1,3}

ALL : XJ, 1984-89 use 83500263 ⁴
 ALL : XJ, 1990 use 5252506 ⁴
 ALL : XJ, 1984-90 use J0994345 ¹

NOTE:

1. W/ DANA 44 AXLE.
2. W/ AMC 20 AXLE.
3. W/ DANA 60 (J20) USE J8122379.
4. W/ DANA 35 AXLE.

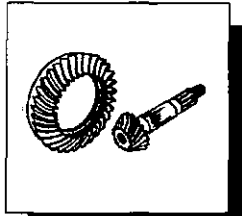

9.050

GEAR SET, Rear Axle Ring Gear and Pinion

2.73 Ratio

SJ : 1980-85 J8132699 (20)

3.07 Ratio

SJ : 1979 J8129224 (44)
 XJ : 1987-90 83505472 (35)
 XJ : 1986-90 83503197 (44)

3.08 Ratio

XJ : 1986-87 83503021 (35)

3.31 Ratio

SJ : 1980-85 J8132700 (20)
 SJ : 1986-90 J8134219 (44)
 XJ : 1984-90 83503000 (35)

3.54 Ratio

SJ : 1979 J8129217 (44)
 SJ : 1986-90 83503437 (44)

3.55 Ratio

XJ : 1986-87 83504210 (44)

3.73 Ratio

J20 : 1979-90 J8129234 (60)
 XJ : 1984-85 83503018 (35)

4.09 Ratio

SJ : 1979 J8129225 (44)

4.10 Ratio

SJ : 1980 J8127072 (20)
 MJ : 1986-87 J8127072 (20)
 J20 : 1979-80 J8129235 (60)

4.11 Ratio

XJ : 1986-90 83504938 (35)

4.56 Ratio

XJ : 1986-90 83504377 (35)

4.88 Ratio

SJ : 1979-86 J8129236 (60)

NOTES: (20) AMC Model 20 Axle
 (35) DANA Model 35 Axle
 (44) DANA Model 44 Axle
 (60) DANA Model 60 Axle

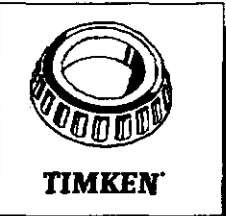

9.041

BEARING, Rear Axle Differential Side

ALL : SJ, 1979 use J0805311
 ALL : SJ, 1980-86 use J3172565

ALL : XJ, 1984-90 use J3156052

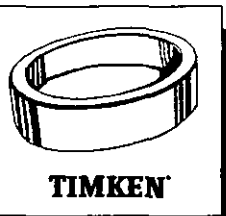

9.041

CUP, Rear Axle Differential Side

ALL : SJ, 1979 use J0052980
 ALL : SJ, 1980-86 use J3172566

ALL : XJ, 1984-90 use J3171166

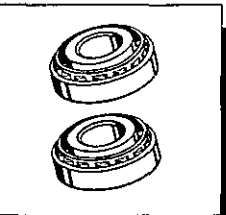

9.044

BEARING KIT, Rear Axle Differential (Includes 2 Cups & 2 Cones) with Dana Model 44 (J20)

6 Cyl : SJ, 1979-89 use J8124028
 8 Cyl : SJ, 1979-89 use J8124028

4 Cyl : XJ, 1986-89 use 33002984
 V6 Cyl : XJ, 1986-87 use 83500728
 I6 Cyl : XJ, 1986-89 use 33002984
 I6 Cyl : XJ, 1986-89 use 83505398

NOTE: 1. 1979 INCLUDES WAGONEER & CHEROKEE MODELS.
 2. THIS IS FOR COMANCHE PICKUP TRUCK.

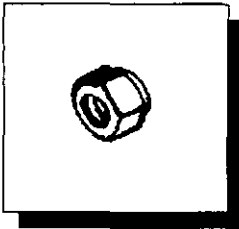

9.050

NUT, Rear Axle Pinion

6 Cyl : SJ, 1980-85 use J3182601 ^{1,3}
 6 Cyl : SJ, 1979,86 use J0801367 ^{1,2}
 8 Cyl : SJ, 1980-85 use J3182601 ^{1,3}
 8 Cyl : SJ, 1979,86 use J0801367 ^{1,2}

4 Cyl : XJ, 1984-90 use J3182601 ²
 V6 Cyl : XJ, 1984-90 use J3182601 ²
 I6 Cyl : XJ, 1987-90 use J3182601 ²
 Diesel : XJ, 1984-90 use J3182601 ²

NOTE: 1. FOR J20 USE J0919585.
 2. FOR MODEL 44, USE J0801367.
 3. USED WITH AMC MODEL 20.

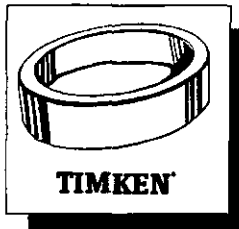

9.055

CUP, Rear Axle Pinion - Outer

6 Cyl : SJ, 1979-85 use J3172134 ²
 6 Cyl : SJ, 1979,86 use J0052879 ¹
 8 Cyl : SJ, 1979-85 use J3172134 ²
 8 Cyl : SJ, 1979,86 use J0052879 ¹

4 Cyl : XJ, 1984-90 use J3156062 ¹
 V6 Cyl : XJ, 1984-90 use J3156062 ¹
 I6 Cyl : XJ, 1987-90 use J3156062 ¹
 Diesel : XJ, 1984-90 use J3156062 ¹

NOTE: 1. FOR MODEL 44, USE J0052879.
 2. USED WITH AMC MODEL 20.



9.052

BEARING, Rear Axle Pinion - Outer

6 Cyl : SJ, 1979-85 use J3172135 ²
 6 Cyl : SJ, 1986-89 use J0052878 ¹
 8 Cyl : SJ, 1979-85 use J3172135 ²
 8 Cyl : SJ, 1986-89 use J0052878 ¹

4 Cyl : XJ, 1984-90 use J3156063 ¹
 V6 Cyl : XJ, 1984-86 use J3156063 ¹
 I6 Cyl : XJ, 1987-90 use J3156063 ¹
 Diesel : XJ, 1984-90 use J3156063 ¹

NOTE: 1. FOR MODEL 44, USE J0052878.
 2. USED WITH AMC MODEL 20.



9.055

CUP, Rear Axle Pinion - Inner

6 Cyl : SJ, 1979-85 use J3172564 ²
 6 Cyl : SJ, '79,86-90 use J0052877 ¹
 8 Cyl : SJ, 1979-85 use J3172564 ²
 8 Cyl : SJ, '79,86-90 use J0052877 ¹

4 Cyl : XJ, 1984-90 use J3156065 ¹
 V6 Cyl : XJ, 1984-86 use J3156065 ¹
 I6 Cyl : XJ, 1987-90 use J3156065 ¹
 Diesel : XJ, 1984-90 use J3156065 ¹

NOTE: 1. FOR MODEL 44, USE J0052877.
 2. USED WITH AMC MODEL 20.



9.052

BEARING, Rear Axle Pinion - Inner

6 Cyl : SJ, 1979-85 use J3172563 ²
 6 Cyl : SJ, '79,86-90 use J0807266 ¹
 8 Cyl : SJ, 1979-85 use J3172563 ²
 8 Cyl : SJ, '79,86-90 use J0807266 ¹

4 Cyl : XJ, 1984-90 use J3170947 ¹
 V6 Cyl : XJ, 1984-86 use J3170947 ¹
 I6 Cyl : XJ, 1987-90 use J3170947 ¹
 Diesel : XJ, 1984-90 use J3170947 ¹

NOTE: 1. FOR DANA MODEL 44.
 2. USED WITH AMC MODEL 20.



9.055

**BEARING KIT, Rear Axle Pinion
 Bearing & Cup - Outer - (60)**

6 Cyl : J20, 1979-90 use J8124026
 8 Cyl : J20, 1979-90 use J8124026



9.055

**BEARING KIT, Rear Axle Pinion
 Bearing & Cup - Inner - (60)**

6 Cyl : J20, 1979-90 use J8124027
 8 Cyl : J20, 1979-90 use J8124027

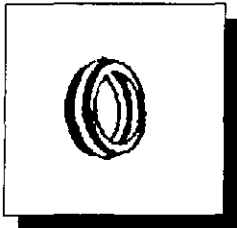

9.056

SPACER, Rear Axle Pinion

6 Cyl : SJ, 1979-85 use J3185971 ¹
 8 Cyl : SJ, 1979-85 use J3185971 ¹

4 Cyl : XJ, 1984-90 use J3175779 ²
 V6 Cyl : XJ, 1984-86 use J3175779 ²
 16 Cyl : XJ, 1987-90 use J3175779 ²
 Diesel : XJ, 1984-90 use J3175779 ²

NOTE: 1. USED WITH AMC MODEL 20.
 2. USED WITH DANA MODEL 35.

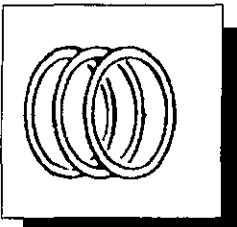

9.057

SHIM SET, Rear Axle Pinion

Adjusting

6 Cyl : SJ, 1980-85 use 3205533K ^{1,3}
 6 Cyl : SJ, '79,86-90 use J8129221 ¹
 8 Cyl : SJ, 1980-85 use 3205533K ^{1,3}
 8 Cyl : SJ, '79,86-90 use J8129221 ¹

4 Cyl : XJ, 1984-90 use 83503003 ²
 V6 Cyl : XJ, 1984-86 use 83503003 ²
 16 Cyl : XJ, 1987-90 use 83503003 ²
 Diesel : XJ, 1984-90 use 83503003 ²

NOTE: 1. FOR J20 USE J8129246 (60).
 2. WITH MODEL 44, USE J8129221.
 3. USED WITH AMC MODEL 20.

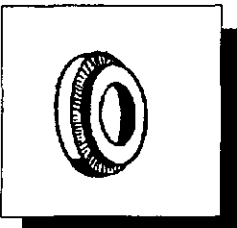

9.064

OIL SEAL, Rear Axle Pinion Bearing

6 Cyl : SJ, 1980-85 use J3208474 ¹
 6 Cyl : SJ, '79,86-90 use 83503390 ^{1,2}
 8 Cyl : SJ, 1980-85 use J3208474 ¹
 8 Cyl : SJ, '79,86-90 use 83503390 ^{1,2}

4 Cyl : XJ, 1984-90 use 83504946 ²
 V6 Cyl : XJ, 1984-86 use 83504946
 16 Cyl : XJ, 1987-90 use 83504946
 Diesel : XJ, 1984-90 use 83504946

NOTE: 1. FOR J20 USE J8134810 (60).
 2. USED WITH DANA 35.
 3. WITH DANA 44 USE 83503390 (w/ TRAC-LOK).
 WITH STANDARD 44 USE J0998092.

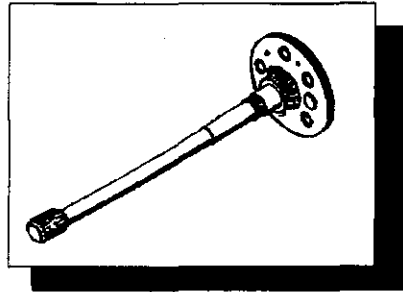

SHAFT, Rear Axle

9.068



LEFT

1979	SJ, w/ Man. Trans	J8124081
1979	SJ, w/ Auto. Trans	J8124034
1979	Cherokee Chief	J8124034
1979	J20, w/ Man. Trans	J8124448
1979	J20, w/ Auto. Trans	J8130010
1980-86	SJ, w/ AMC Model 20 Axle	J3235807
1980-83	Cherokee Chief	J3235811
1980-86	J10, w/ AMC Model 20 Axle	J3235809
1980-90	J20	J8131932
1986-90	SJ, w/ DANA Model 44	83503091
1986-90	J10, w/ DANA Model 44	83503095
1984-89	XJ, w/ DANA 35 (less Brgs)	53000403
1984-89	XJ, w/ DANA 35 (inc. Brgs)	83502883
1986-90	XJ, w/ DANA 44	83504961
1990	XJ, w/ DANA 35 (less ABS)	5252957
1990	XJ, w/ DANA 35 (inc. ABS)	5252949

RIGHT

1979	SJ, w/ Man. Trans	J8124080
1979	SJ, w/ Auto. Trans	J8124084
1979	Cherokee Chief	J8124080
1979	J20, w/ Man. Trans	J8124447
1979	J20, w/ Auto. Trans	J8130009
1980-86	SJ, w/ AMC Model 20 Axle	J3235806
1980-83	Cherokee Chief	J3235810
1980-86	J10, w/ AMC Model 20 Axle	J3235808
1980-90	J20	J8131932
1986-90	SJ, w/ DANA Model 44	83503090
1986-90	J10, w/ DANA Model 44	83503096
1984-89	XJ, w/ DANA 35 (less Brgs)	53000404
1984-89	XJ, w/ DANA 35 (inc. Brgs)	83502882
1986-90	XJ, w/ DANA 44	83504960
1990	XJ, w/ DANA 35 (less ABS)	5252956
1990	XJ, w/ DANA 35 (inc. ABS)	5252948

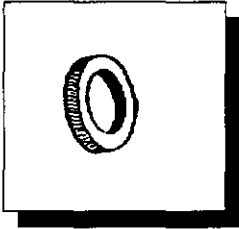

9.072

OIL SEAL, Rear Axle (Inner)

6 Cyl : SJ, 1979 use J0994258 ¹
 6 Cyl : SJ, 1980-85 use J3235929 ²
 6 Cyl : SJ, 1986-90 use 83503063 ¹
 8 Cyl : SJ, 1979 use J0994258 ¹
 8 Cyl : SJ, 1980-85 use J3235929 ²
 8 Cyl : SJ, 1986-90 use 83503063 ¹

4 Cyl : XJ, 1984-90 use 53000477 ³
 V6 Cyl : XJ, 1984-86 use 53000477 ³
 I6 Cyl : XJ, 1987-90 use 53000477 ³
 Diesel : XJ, 1984-90 use 53000477 ³

NOTE: 1. USED WITH DANA 44.
 2. USED WITH AMC 20.
 3. WITH DANA 44 AXLE USE 83503063.

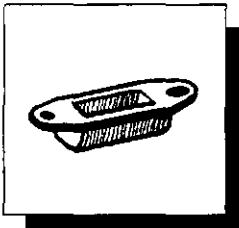

9.086

BUMPER, Rear Axle

6 Cyl : SJ, 1979-90 use J5355483
 8 Cyl : SJ, 1979-90 use J5355483

4 Cyl : XJ, 1984-90 use 52004297 ¹
 V6 Cyl : XJ, 1984-86 use 52004297 ¹
 I6 Cyl : XJ, 1987-90 use 52004297 ¹
 Diesel : XJ, 1984-90 use 52004297 ¹

NOTE: 1. FOR COMANCHE USE: 52002382 FOR (2.9")
 52002381 FOR (3.5")
 52002393 FOR (4.0")
 52002078 FOR (4.6")

**PROPELLER
SHAFT**

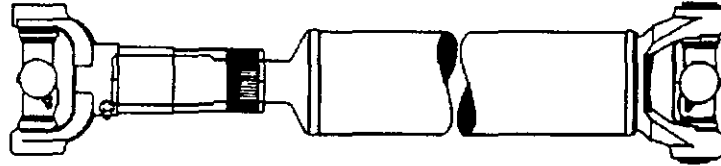

FRONT

<u>CYL</u>	<u>MODEL</u>	<u>YEAR</u>	<u>COMMENTS</u>	<u>LENGTH</u>	<u>PART NO.</u>
6	J-series	1979	T15A, 3 Speed	21.00	J5359384
6	J-series	1979	T18, 4 Speed	25.00	J5359386
6	J-series	1979	Automatic	29.00	J5359385
6	J-series	1980/	T18, 4 Speed	26.36	J5360995
6	J-series	1980/	Automatic	29.20	J5360997
6	J-series	1982/	T5, 5 Speed	28.98	J5363399
8	J-series	1979	Automatic	25.00	J5759386
8	J-series	1979	T15A, 3 Speed	20.00	J5359383
8	J-series	1979	T18, 4 Speed	25.00	J5359386
8	J-series	1980/	Automatic	25.70	J5360996
8	J-20	1980/	T18, 4 Speed, 131" Wheelbase	35.40	J5360998
8	J-series	1980/	T18, 4 Speed	26.36	J5360995
Dsl	XJ	1984-86	GKN Type	27.00	53000029
Dsl	XJ	1986	Heavy Duty, Spicer	25.25	53004812
Dsl	XJ	1987	Heavy Duty, Spicer	25.25	53003235
Dsl	XJ	1988/	KDX, Diesel	29.25	53005543
4	XJ	1984-86	GKN Type	27.00	53000029
4	XJ	1986	Heavy Duty, Spicer	25.25	53004812
4	XJ	1987-88	Manual Transmission	25.25	53003235
4	XJ	1987-88	Automatic	28.95	53003912
4	XJ	1989-90	Automatic	28.95	53005540
6	XJ	1984-86	GKN Type	27.00	53000029
6	XJ	1986	Heavy Duty, Spicer	25.25	53004812
6	XJ	1987/	Manual Transmission	29.25	53005543
6	XJ	1987/	Automatic	30.65	53005542



PROPELLER SHAFT CONTINUED

REAR

<u>CYL</u>	<u>MODEL</u>	<u>YEAR</u>	<u>COMMENTS</u>	<u>LENGTH</u>	<u>PART NO.</u>
6	Wag-Cher	1979	T15A, 3 Speed		J5359916
6	Wag-Cher	1979	T18, 4 Speed		J5359914
6	Wag-Cher	1979	Automatic	38.00	J5356514
6	Wag-Cher	1980/	Auto., with Full Time Transfer Case	32.20	J5360999
6	Wag-Cher	1980/	Auto., with Part Time Transfer Case	37.32	J5361011
6	Wag-Cher	1981/	T18, 4 Speed	40.40	J5361007
6	Wag-Cher	1982/	T5, 5 Speed	38.87	J5363370
6	Wag-Cher	1982/	Automatic, with Selec-Trac	32.20	J5360999
6	J-10	1979	T15A, 3 Speed, 119" Wheelbase	38.13	J5356515
6	J-10	1979	T18, 4 Speed, 119" Wheelbase		J5356518
6	J-10	1979	Automatic, 119" Wheelbase		J5356519
6	J-10	1980/	T18, 4 Speed, 119" Wheelbase	50.54	J5361008
6	J-10	1980/	Auto., with Full Time T. C., 119" w.b.	42.32	J5361000
6	J-10	1980/	Auto., with Part Time T. C., 119" w.b.	47.42	J5361012
6	J-10	1979	Automatic, 131" Wheelbase		J5351037
6	J-10	1979	T15A, 3 Speed, 131" Wheelbase		J5356522
6	J-10	1979	T18, 4 Speed, 131" Wheelbase		J5356523
6	J-10	1980/	T18, 4 Speed, 131" Wheelbase	62.46	J5361009
6	J-10	1980/	Auto., with Full Time T. C., 131" w.b.	54.20	J5361001
6	J-10	1980/	Auto., with Part Time T. C., 131" w.b.	59.30	J5361013
6	J-10	1982/	T5, 5 Speed, 119" Wheelbase	48.59	J5363371
6	J-10	1982/	Auto., with Selec-Trac, 119" Wheelbase	42.32	J5361000
6	J-10	1982/	T5, 5 Speed, 131" Wheelbase	60.90	J5363372
6	J-10	1982/	Auto., with Selec-Trac, 131" Wheelbase	54.20	J5361001
6	J-20	1979	T18, 4 Speed, 131" Wheelbase		J5356526
6	J-20	1980/	T18, 4 Speed, 131" Wheelbase	53.20	J5361010
6	J-20	1979	Automatic, 131" Wheelbase	38.13	J5356515
6	J-20	1980	Auto., with Full Time T. C., 131" w.b.		J5361002
6	J-20	1980	Auto., with Part Time T. C., 131" w.b.		J5361014
8	Wag-Cher	1979	T15A, 3 Speed		J5359911
8	Wag-Cher	1979	T18, 4 Speed		J5359914
8	Wag-Cher	1979	Automatic	41.98	J5356513
8	Wag-Cher	1980/	T18, 4 Speed	40.40	J5361007
8	Wag-Cher	1980/	Auto., with Full Time Transfer Case	36.14	J5361003
8	Wag-Cher	1980/	Auto., with Part Time Transfer Case	41.23	J5361015
8	Wag-Cher	1982/	T5, 5 Speed	38.87	J5363370
8	Wag-Cher	1982/	Automatic with Selec-Trac	36.14	J5361003
8	J-10	1979	T15A, 3 Speed, 119" Wheelbase	38.13	J5356515
8	J-10	1979	T18, 4 Speed, 119" Wheelbase		J5356518
8	J-10	1979	Automatic, 119" Wheelbase		J5356520
8	J-10	1980/	Auto., with Full Time T. C., 119" w.b.	46.26	J5361004
8	J-10	1980/	Auto., with Part Time T. C., 119" w.b.	51.32	J5361016
8	J-10	1980/	T18, 4 Speed, 119" Wheelbase		J5361008
8	J-10	1982/	T5, 5 Speed, 119" Wheelbase	48.59	J5363371

REAR PROPELLER SHAFT CONTINUED



<u>CYL</u>	<u>MODEL</u>	<u>YEAR</u>	<u>COMMENTS</u>	<u>LENGTH</u>	<u>PART NO.</u>
8	J-10	1982/	Auto., with Selec-Trac, 119" Wheelbase	46.26	J5361004
8	J-10	1979	T15A, 3 Speed, 131" Wheelbase		J5361039
8	J-10	1979	T18, 4 Speed, 131" Wheelbase		J5356523
8	J-10	1979	Automatic, 131" Wheelbase		J5356054
8	J-10	1980/	T18, 4 Speed, 131" Wheelbase	62.46	J5361009
8	J-10	1980/	Auto., with Full Time T. C., 131" w.b.	58.14	J5361005
8	J-10	1980/	Auto., with Part Time T. C., 131" w.b.	63.20	J5361017
8	J-10	1982/	T5, 5 Speed, 131" Wheelbase	60.90	J5363372
8	J-10	1982/	Automatic with Selec-Trac	58.14	J5361005
8	J-20	1979	T15A, 3 Speed, 131" Wheelbase		J5356522
8	J-20	1979	T18, 4 Speed, 131" Wheelbase		J5356526
8	J-20	1979	Automatic, 131" Wheelbase		J5358878
8	J-20	1980/	Auto., with Full Time T. C., 131" w.b.	57.74	J5361006
8	J-20	1980/	Auto., with Part Time T. C., 131" w.b.	62.80	J5361018
8	J-20	1980/	T18, 4 Speed, 131" Wheelbase	53.20	J5361010
4	XJ	1984-85	with Manual Trans., 229 Transfer Case		53000035
4	XJ	1984-85	Automatic Trans., 229 Transfer Case		52042503
4	XJ	1984-85	T4, 4 Speed; T5, 5 Speed, 207 T. C.		53000037
4	XJ	1984-85	AX-5, AX-15, 5 Speed, 207 Transfer Case		53000036
4	XJ	1986	with Model 35 Axle, 228 Transfer Case		53000034
4	XJ	1987/	Manual Trans., Model 35 Axle, 207 T. C.		53003241
4	XJ	1987/	Auto Trans., Model 35 Axle, 207 T. C.		53003914
4	MJ	1986	Model 35 Axle, 228 Transfer Case		53001259
4	MJ	1986	Model 35 Axle, 228 Transfer Case		53001979
4	MJ	1986	Model 20, 44 Axle, 207 Transfer Case		53004446
4	MJ	1986	Model 44 Axle, 207 Transfer Case		53004350
4	MJ	1987/	Manual Trans., Model 35 Axle, 6' Box		53004671
4	MJ	1987/	Auto Trans., Model 35 Axle, 6' Box		53004668
4	MJ	1987/	Manual Trans., Model 35 Axle, 7' Box		53004656
4	MJ	1987/	Auto Trans., Model 35 axle, 7' Box		53004655
4	MJ	1987/	Manual Trans., Model 44 Axle, 7' Box		53004657
6	XJ	1984-86	Auto Trans., 229 Transfer Case		53000034
6	XJ	1984-86	Auto Trans., 207 Transfer Case		53000036
6	XJ	1984-85	T4, 4 Speed, T5, 5 Speed, 207 T. C.		53000037
6	XJ	1987/	Manual Trans., Model 35 Axle		53003242
6	XJ	1987/	Auto Trans., Model 35 Axle		53003246
6	XJ	1987/	Manual Trans., Model 44 Axle		53005009
6	XJ	1987/	Auto Trans., Model 44 Axle		53005008
6	MJ	1986	Model 35 Axle, 228 Transfer Case		53001259
6	MJ	1986	Model 44 Axle, 228 Transfer Case		53001979
6	MJ	1986	Model 35 Axle, 207 Transfer Case		53004446
6	MJ	1986	Model 44 Axle, 207 Transfer Case		53004350
6	MJ	1987/	Manual Trans., Model 35 Axle, 6' Box		53004669
6	MJ	1987/	Auto Trans., Model 35 Axle, 6' Box		53004670
6	MJ	1987/	Manual Trans., Model 44 Axle, 6' Box		53005013
6	MJ	1987/	Auto Trans., Model 44 Axle, 6' Box		53005012
6	MJ	1987/	Manual Trans., Model 35 Axle, 7' Box		53004662
6	MJ	1987/	Auto Trans., Model 35 Axle, 7' Box		53004654
6	MJ	1987/	Manual Trans., Model 44 Axle, 7' Box		53004665
6	MJ	1987/	Auto Trans., Model 44 Axle, 7' Box		53004663

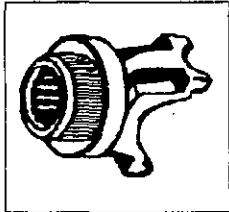
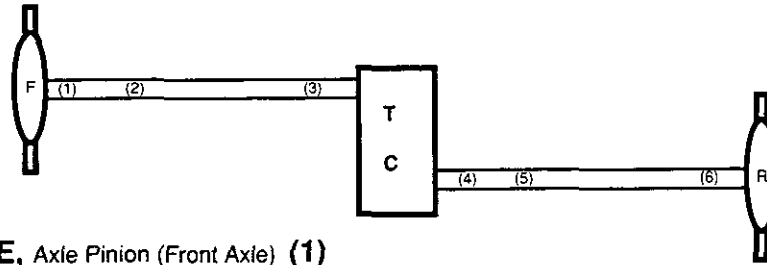

9.104

YOKE, Axle Pinion (Front Axle) (1)

6 Cyl : SJ, 1979-80 use J0935685
 6 Cyl : SJ, 1981-86 use J8133241
 6 Cyl : SJ, 1987-90 use 83503388
 8 Cyl : SJ, 1979-80 use J0935685
 8 Cyl : SJ, 1981-86 use J8133241
 8 Cyl : SJ, 1987-90 use 83503388

4 Cyl : XJ, 1984-86 use J8133241
 4 Cyl : XJ, 1987-90 use 83503388
 V6 Cyl : XJ, 1984-86 use J8133241
 I6 Cyl : XJ, 1987-90 use 83503388
 Diesel : XJ, 1984-86 use J8133241
 Diesel : XJ, 1987-90 use 83503388

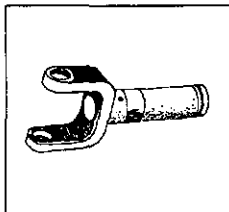

9.104

YOKE, Front Propeller Shaft Universal Joint Sleeve (2)

6 Cyl : SJ, 1979-85 use J0932209
 6 Cyl : SJ, 1986-89 use 83501594
 8 Cyl : SJ, 1979-85 use J0932209
 8 Cyl : SJ, 1986-89 use 83501594

4 Cyl : XJ, 1984-85 use 53000741¹
 4 Cyl : XJ, 1986-90 use 83501594²
 V6 Cyl : XJ, 1984-86 use 53000741¹
 I6 Cyl : XJ, 1987-90 use 83501594²
 Diesel : XJ, 1984-85 use 53000741¹
 Diesel : XJ, 1986-90 use 83501594²

NOTE: 1. WITH GKN TYPE PROP. SHAFT.
 2. WITH DANA TYPE PROP. SHAFT.

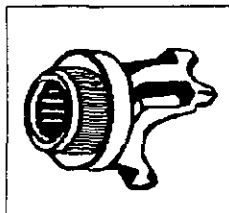

9.104

YOKE, Transfer Case Front Output (3)

W/ MODEL 207 TRANSFER CASE USE 53000906¹
 W/ MODEL 208 TRANSFER CASE USE J8130818
 W/ MODEL 219 TRANSFER CASE USE J8130818
 W/ MODEL 228 TRANSFER CASE USE J8134272²
 W/ MODEL 229 TRANSFER CASE USE J8134272³
 W/ MODEL 231 TRANSFER CASE USE 83503161
 W/ MODEL 242 TRANSFER CASE USE J8130818⁴

NOTE : 1. W/ TAG NOS. USE 8953003390 AND 8953003559 USE 83502644.
 2. W/ TAG NO. 8953002403 USE 53000905.
 3. 1984-85 USE 53000905.
 4. 1990 USE 13776.

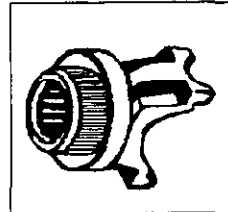

9.104

YOKE, Transfer Case Rear Output (4)

W/ MODEL 207 TRANSFER CASE USE 83503578
 W/ MODEL 208 TRANSFER CASE USE 83503578
 W/ MODEL 219 TRANSFER CASE USE 83503578
 W/ MODEL 228 TRANSFER CASE USE 83503578
 W/ MODEL 229 TRANSFER CASE USE 83503578¹

NOTE : 1. 1990 USE 13775.

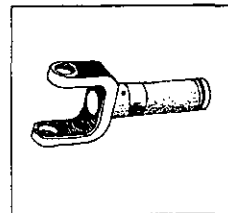

9.104

YOKE, Rear Propeller Shaft Universal Joint Sleeve (5)

6 Cyl : SJ, 1979-89 use J8127263^{1,2}
 8 Cyl : SJ, 1979-89 use J8127263^{1,2}

4 Cyl : XJ, 1984-86 use 83500143²
 4 Cyl : XJ, 1987-90 use 83503574³
 V6 Cyl : XJ, 1984-86 use 83500143²
 I6 Cyl : XJ, 1987-90 use 83503574³
 Diesel : XJ, 1984-86 use 83500143²
 Diesel : XJ, 1987-90 use 83503574³

NOTE: 1. W/ CRIMPED CAP (NOT THREADED), USE J0932209.
 2. W/ 207 TRANSFER CASE & GREASE FITTING ON CAP (NOT YOKE) USE J8134782.
 3. THIS IS FOR 4WD. FOR 2WD WITH MANUAL TRANS. USE 53001987. FOR 2WD WITH AUTO TRANS. USE 83503593.

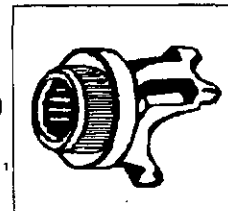

9.104

YOKE, Axle Pinion (Rear Axle) (6)

6 Cyl : SJ, 1979 use J0935685¹
 6 Cyl : SJ, 1980-85 use J8132702
 6 Cyl : SJ, 1986-90 use 83503388
 8 Cyl : SJ, 1979 use J0935685¹
 8 Cyl : SJ, 1980-85 use J8132702
 8 Cyl : SJ, 1986-90 use 83503388

4 Cyl : XJ, 1984-90 use 83503318²
 V6 Cyl : XJ, 1984-86 use 83503318²
 I6 Cyl : XJ, 1987-90 use 83503318²
 Diesel : XJ, 1984-90 use 83503318²

NOTE: 1. FOR J20, 1979-80, USE J0945711, 1981-90 USE J8134809.
 2. WITH MODEL 44 AXLE USE 83503388.

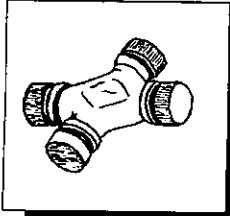

9.107

SPIDER ASSY, Front Propeller Shaft Universal Joint - Front

6 Cyl : SJ, 1979-90 use J8126614
8 Cyl : SJ, 1979-90 use J8126614

4 Cyl : XJ, 1984-90 use J8126614
V6 Cyl : XJ, 1984-86 use J8126614
I6 Cyl : XJ, 1987-90 use J8126614
Diesel : XJ, 1984-90 use J8126614

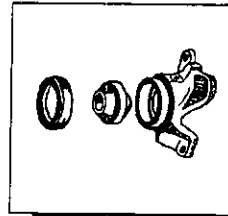

9.110

YOKE KIT, Front Propeller Shaft Socket - Rear (Spicer Type)

6 Cyl : SJ, 1979-88 use J8126796
8 Cyl : SJ, 1979-88 use J8126796

4 Cyl : XJ, 1984-88 use J8126796
4 Cyl : XJ, 1989-90 use J4384663
V6 Cyl : XJ, 1986 use J8126796
I6 Cyl : XJ, 1987-88 use J8126796
I6 Cyl : XJ, 1989-90 use 4384663
Diesel : XJ, 1984-88 use J8126796
Diesel : XJ, 1989-90 use 4384663

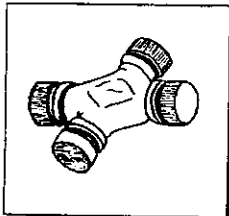

9.107

SPIDER ASSY, Front Propeller Shaft Universal Joint - Center & Rear

6 Cyl : SJ, 1979-90 use J8130750
8 Cyl : SJ, 1979-90 use J8130750

4 Cyl : XJ, 1984-90 use J8130750
V6 Cyl : XJ, 1984-86 use J8130750
I6 Cyl : XJ, 1987-90 use J8130750
Diesel : XJ, 1984-90 use J8130750



9.304

BUMPER, Front Axle

6 Cyl : SJ, 1979-90 use J5355483
8 Cyl : SJ, 1979-90 use J5355483

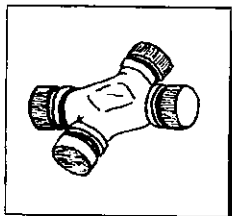

9.107

SPIDER ASSY, Rear Propeller Shaft Universal Joint - Front & Rear

6 Cyl : SJ, 1979-89 use J8126614
8 Cyl : SJ, 1979-89 use J8126614

4 Cyl : XJ, 1984-90 use J8126614
V6 Cyl : XJ, 1984-86 use J8126614
I6 Cyl : XJ, 1987-90 use J8126614
Diesel : XJ, 1984-90 use J8126614

NOTE: 1. FOR "DETROIT UNIVERSAL" TYPE, 1979-80, USE J0940802.

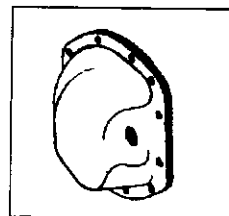

9.307

COVER, Front Axle Housing (W/ Gasket & Bolts)

6 Cyl : SJ, 1979-90 use J8124352
8 Cyl : SJ, 1979-90 use J8124352

4 Cyl : XJ, 1984-90 use 83500194
V6 Cyl : XJ, 1984-86 use 83500194
I6 Cyl : XJ, 1987-90 use 83500194
Diesel : XJ, 1984-90 use 83500194

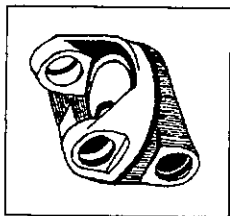

9.110

YOKE, Front Propeller Shaft (Spicer Type) - Center

6 Cyl : SJ, 1979-90 use J8130296
8 Cyl : SJ, 1979-90 use J8130296

4 Cyl : XJ, 1986-90 use J8130296
V6 Cyl : XJ, 1986-86 use J8130296
I6 Cyl : XJ, 1987-90 use J8130296
Diesel : XJ, 1986-90 use J8130296

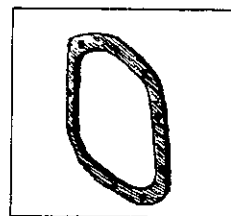

9.307

GASKET, Front Axle Housing Cover Model 44

6 Cyl : SJ, 1979-90 use J8122409
8 Cyl : SJ, 1979-90 use J8122409

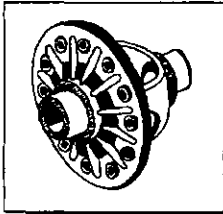

9.321

CASE ASSY, Front Axle Differential

Model 44 - 2.73, 3.07, 3.31, 3.54, 3.73 Ratios

6 Cyl: SJ, 1979-90 use J8129226
 8 Cyl: SJ, 1979-90 use J8129226

NOTE: 1. WITH SELEC-TRAC, 1982-84, USE J8134224.

Model 44 - 4.09, 4.88 Ratios

6 Cyl: SJ, 1979-86 use J8124077
 8 Cyl: SJ, 1979-86 use J8124077

Model 30 - 3.07, 3.31, 3.54, 3.55 Ratios

4 Cyl: XJ, 1984-89 use 83500168
 4 Cyl: XJ, 1990 use 5252582
 V6 Cyl: XJ, 1984-86 use 83500168
 I6 Cyl: XJ, 1987-89 use 83500168
 I6 Cyl: XJ, 1990 use 5252582
 Diesel: XJ, 1984-89 use 83500168
 Diesel: XJ, 1990 use 5252582

Model 30 - 3.73, 4.10, 4.56 Ratios

4 Cyl: XJ, 1984-89 use 83500169
 4 Cyl: XJ, 1990 use 5252590
 V6 Cyl: XJ, 1984-86 use 83500169
 I6 Cyl: XJ, 1987-89 use 83500169
 I6 Cyl: XJ, 1990 use 5252590
 Diesel: XJ, 1984-89 use 83500169
 Diesel: XJ, 1990 use 5252590

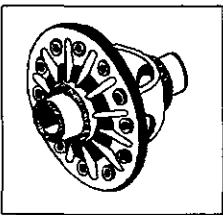

9.324

CASE, Front Axle Differential
 Model 44 - 2.73, 3.09, 3.31, 3.54 & 3.73 Ratio

6 Cyl : SJ, 1979-90 use J8124039
 8 Cyl : SJ, 1983-90 use J8124039

NOTE: 1. WITH SELEC-TRAC USE COMPLETE CASE ASSY.

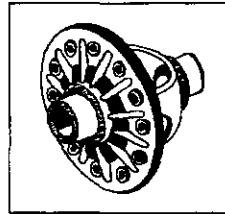

9.324

CASE, Front Axle Differential
 Model 44 - 4.09, 4.88 Ratio

6 Cyl : SJ, 1979-86 use J8124078
 8 Cyl : SJ, 1979-86 use J8124078

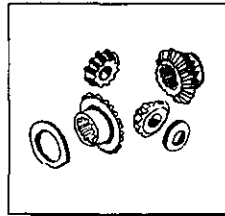

9.327

GEAR SET, Front Axle Differential Side

6 Cyl : SJ, 1979-90 use J8129228
 8 Cyl : SJ, 1979-90 use J8129228

4 Cyl : XJ, 1984-89 use 83500190
 4 Cyl : XJ, 1990 use 5252591
 V6 Cyl : XJ, 1984-86 use 83500190
 I6 Cyl : XJ, 1987-89 use 83500190
 I6 Cyl : XJ, 1990 use 5252591
 Diesel : XJ, 1984-89 use 83500190
 Diesel : XJ, 1990 use 5252591

NOTE: 1. WITH S-TRAC, 1982-84, USE J8134225.

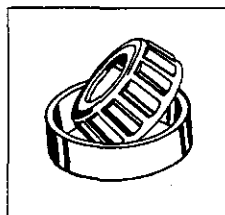

9.341

BEARING KIT, Front Axle Differential Side (With 2 Bearings & 2 Cups)

6 Cyl : SJ, 1979-90 use J8124071
 8 Cyl : SJ, 1979-90 use J8124071

4 Cyl : XJ, 1984-90 use J8126500
 V6 Cyl : XJ, 1984-86 use J8126500
 I6 Cyl : XJ, 1987-90 use J8126500
 Diesel : XJ, 1984-90 use J8126500

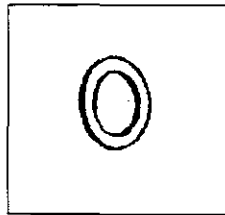

9.345

SHIM SET, Front Axle Differential Case Side Bearing

6 Cyl : SJ, 1979-90 use J8124791
 8 Cyl : SJ, 1979-90 use J8124791

4 Cyl : XJ, 1984-90 use 83500191
 V6 Cyl : XJ, 1984-86 use 83500191
 I6 Cyl : XJ, 1987-90 use 83500191
 Diesel : XJ, 1984-90 use 83500191

NOTE: 1. WITH SELEC-TRAC, 1982-84, USE J8129222.

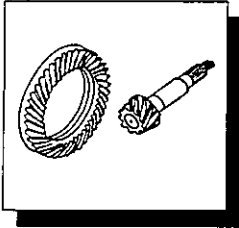

GEAR SET, Front Axle

With Pinion Bearing, Shim Sets, Nut, Washer, Seal and Slinger

9.350

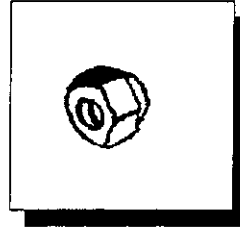

9.350

NUT, Front Axle Pinion

6 Cyl : SJ, 1979-90 use J0801367
8 Cyl : SJ, 1979-90 use J0801367

4 Cyl : XJ, 1984-90 use J0801367
V6 Cyl : XJ, 1984-86 use J0801367
I6 Cyl : XJ, 1987-90 use J0801367
Diesel : XJ, 1984-90 use J0801367

2.73 RATIO

SJ : 1980-90 use J8134222

3.07 RATIO

SJ : 1979 use J8129224
XJ : 1984-90 use 83500187

3.31 RATIO

SJ : 1980-90 use J8134219
XJ : 1984-86 use 83500188

NOTE: 1. w/ SELEC-TRAC, 1982-84, USE J8134219.

3.54 RATIO

SJ : 1979 use J8132917
XJ : 1986-90 use 83502355

3.55 RATIO

XJ : 1986-90 use 83505480

3.73 RATIO

SJ : 1979-90 use J8124777
XJ : 1984-85 use 83500189

4.09 RATIO

SJ : 1979-80 use J8124076

4.10 RATIO

XJ : 1984-90 use 83502353

4.56 RATIO

XJ : 1984-90 use 83503424

4.88 RATIO

SJ : 1979-86 use J8124386

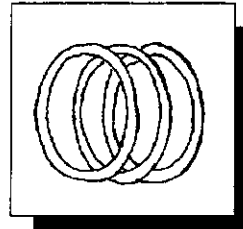

9.350

SHIM SET, Front Axle Pinion

6 Cyl : SJ, 1979-89 use J8129221
8 Cyl : SJ, 1979-89 use J8129221

4 Cyl : XJ, 1984-90 use 83500192
V6 Cyl : XJ, 1984-86 use 83500192
I6 Cyl : XJ, 1987-90 use 83500192
Diesel : XJ, 1984-90 use 83500192

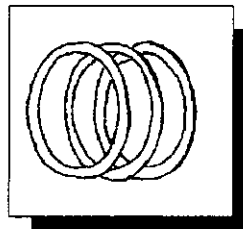

9.350

SHIM SET, Front Axle Differential and Pinion

6 Cyl : SJ, 1979-86 use J8129223
8 Cyl : SJ, 1979-86 use J8129223



9.352

BEARING, Front Axle Pinion

Inner Pinion

6 Cyl : SJ, 1979-90 use J0807266
8 Cyl : SJ, 1979-90 use J0807266

Outer Pinion

6 Cyl : SJ, 1979-90 use J0052878
8 Cyl : SJ, 1979-90 use J0052878

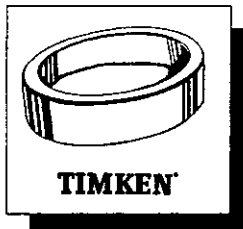

9.355

CUP, Front Axle Pinion Bearing

Inner Pinion

6 Cyl : SJ, 1979-90 use J0052877
8 Cyl : SJ, 1979-90 use J0052877

Outer Pinion

6 Cyl : SJ, 1979-90 use J0052879
8 Cyl : SJ, 1979-90 use J0052879



TIMKEN

9.355

BEARING KIT, Front Axle Pinion Kit
(Includes Bearing & Cup)

Inner Pinion

6 Cyl : SJ, 1979-90 use J8124051
8 Cyl : SJ, 1979-90 use J8124051

4 Cyl : XJ, 1984-90 use J8126499
V6 Cyl : XJ, 1984-86 use J8126499
I6 Cyl : XJ, 1987-90 use J8126499
Diesel : XJ, 1984-90 use J8126499

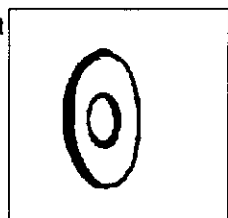

9.364

SLINGER, Front Axle Pinion Bearing
Dust (Outer)

6 Cyl : SJ, 1979-90 use J0636566
8 Cyl : SJ, 1979-90 use J0636566

4 Cyl : XJ, 1984-90 use J0636566
V6 Cyl : XJ, 1984-86 use J0636566
I6 Cyl : XJ, 1987-90 use J0636566
Diesel : XJ, 1984-90 use J0636566



TIMKEN

9.355

BEARING KIT, Front Axle Pinion Kit
(Includes Bearing & Cup)

Outer Pinion

6 Cyl : SJ, 1979-90 use J8124052
8 Cyl : SJ, 1979-90 use J8124052

4 Cyl : XJ, 1984-90 use J8124052
V6 Cyl : XJ, 1984-86 use J8124052
I6 Cyl : XJ, 1987-90 use J8124052
Diesel : XJ, 1984-90 use J8124052

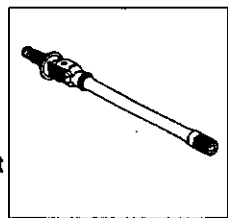

9.368

SHAFT ASSY, Front Axle Drive

SPICER®



LEFT

1979	SJ	J8128551
1979	Cherokee Chief	J8128553
1979	J10, J20	J8128553
1980-90	SJ	J8132913
1980-90	J10, J20	J8132916
1984-87	XJ, less Disc. Axle	53000227
1988-89	XJ, less Disc. Axle	53000684
1990	XJ, less Disc. Axle	5252585
1989	XJ, less Disc. Axle with ABS Brakes	83506006
1990	XJ, less Disc. Axle with ABS Brakes	5252587
1984-89	XJ, with Disc. Axle	53000684
1990	XJ, with Disc. Axle	5252585

RIGHT

1979	SJ	J8128550
1979	Cherokee Chief	J8128552
1979	J10, J20	J8128552
1980-90	SJ	J8132912
1980-90	J10, J20	J8132915
1984-85	XJ, with Disc. Axle	53000686
1986-89	XJ, with Disc. Axle	53000224
1990	XJ, with Disc. Axle	5252972
1984-87	XJ, less Disc. Axle	53002128
1988-89	XJ, less Disc. Axle	53002134
1989	XJ, less Disc. Axle with ABS Brakes	83506005
1990	XJ, less Disc. Axle with ABS Brakes	5252586
1990	XJ, less Disc. Axle	5252584

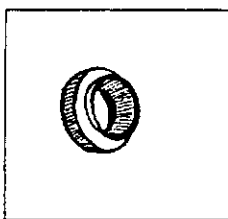

9.364

OIL SEAL, Front Axle Pinion Bearing

6 Cyl : SJ, 1979-90 use J0998092
8 Cyl : SJ, 1979-90 use J0998092

4 Cyl : XJ, 1984-90 use J0998092
V6 Cyl : XJ, 1984-86 use J0998092
I6 Cyl : XJ, 1987-90 use J0998092
Diesel : XJ, 1984-90 use J0998092

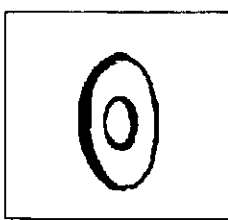

9.364

SLINGER, Front Axle Pinion Bearing
Oil (Inner)

6 Cyl : SJ, 1979-90 use J0916372
8 Cyl : SJ, 1979-90 use J0916372

4 Cyl : XJ, 1984-90 use J0916372
V6 Cyl : XJ, 1986-86 use J0916372
I6 Cyl : XJ, 1987-90 use J0916372
Diesel : XJ, 1984-90 use J0916372

DISC. AXLE = DISCONNECT AXLE
ABS = ANTI-LOCK BRAKING SYSTEM

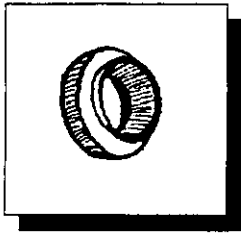

SEAL, Front Axle Inner

9.368

SJ	1979	(2.25")	J8124630
SJ	1979-90	(2.625")	J8129096
SJ	1981-84	(2.25")	83501873
SJ	1982-84	Disc. Axle, Left	J8134216
SJ	1982-84	Disc. Axle, Right	83501009
J10, J20	1982-84	Disc. Axle, Right	83501873
XJ	1984-90	All w/o Disc. Axle	J8121781
XJ	1984-90	Disc. Axle, Left	J8121781
XJ	1984-90	Disc. Axle, Right (2.28")	83500199
XJ	1987-90	Disc. Axle, Right (2.12")	83503504

DISC. AXLE = WITH DISCONNECT AXLE

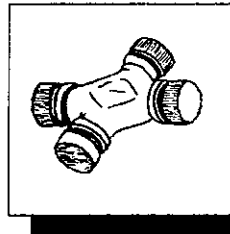

UNIVERSAL JOINT, Front Axle Shaft

9.370

6 Cyl : SJ, 1979-90 use J8126638
8 Cyl : SJ, 1979-90 use J8126638

4 Cyl : XJ, 1984-90 use J8126637
V6 Cyl : XJ, 1984-86 use J8126637
I6 Cyl : XJ, 1987-90 use J8126637
Diesel : XJ, 1984-90 use J8126637

NOTE: 1. WITH ANTI-LOCK BRAKES, 1989, USE J8126638.



SNAP RING, Front Axle Shaft Outer

9.368

6 Cyl : SJ, 1979-90 use J5352166
8 Cyl : SJ, 1979-90 use J5352166



FLANGE, Front Axle Shaft Drive

9.369

6 Cyl : SJ, 1979-90 use J5358494
8 Cyl : SJ, 1979-90 use J5358494

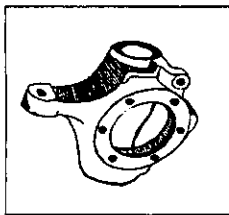

10.004

KNUCKLE, Steering - Left

6 Cyl : SJ, 1979-90 use J8128611
 8 Cyl : SJ, 1979-90 use J8128611

 4 Cyl : XJ, 1984-89 use 53000625
 4 Cyl : XJ, 1990 use 53005603
 V6 Cyl : XJ, 1984-86 use 53000625
 I6 Cyl : XJ, 1987-89 use 53000625
 I6 Cyl : XJ, 1990 use 53005603
 Diesel : XJ, 1984-89 use 53000625
 Diesel : XJ, 1990 use 53005603

NOTE: 1. WITH ANTI-LOCK BRAKES, 1988-90,
 USE 83504923.

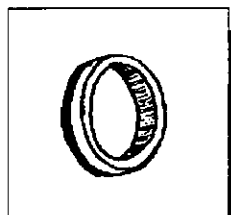

10.004

OIL SEAL, Front Steering Spindle

(2-1/2" or 2-3/4" O.D.)
 6 Cyl : SJ, 1979-90 use J8127350
 8 Cyl : SJ, 1979-90 use J8127350

(1-5/8" "V" Type)
 6 Cyl : SJ, 1979-90 use J8121397
 8 Cyl : SJ, 1979-90 use J8121397

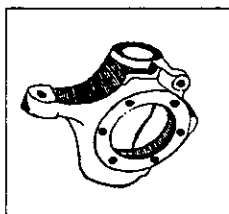

10.004

KNUCKLE, Steering - Right

6 Cyl : SJ, 1979-90 use J8128610
 8 Cyl : SJ, 1979-90 use J8128610

 4 Cyl : XJ, 1984-89 use 53000626
 4 Cyl : XJ, 1990 use 53005602
 V6 Cyl : XJ, 1984-86 use 53000626
 I6 Cyl : XJ, 1987-89 use 53000626
 I6 Cyl : XJ, 1990 use 53005602
 Diesel : XJ, 1984-89 use 53000626
 Diesel : XJ, 1990 use 53005602

NOTE: 1. WITH ANTI-LOCK BRAKES, 1988-90,
 USE 83504922.

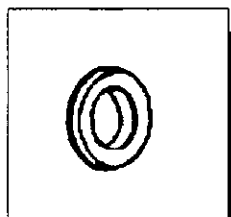

10.004

SPACER, Front Steering Spindle
 (2" or 3" O.D.)

6 Cyl : SJ, 1979 use 8350113
 6 Cyl : SJ, 1988-90 use 83501113
 8 Cyl : SJ, 1979-90 use 83501113

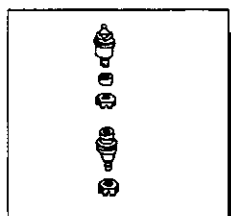

10.006

STUD KIT, Steering Knuckle Ball

6 Cyl : SJ, 1979-90 use J8124333
 8 Cyl : SJ, 1979-90 use J8124333

 4 Cyl : XJ, 1984-90 use 83500202
 V6 Cyl : XJ, 1984-86 use 83500202
 I6 Cyl : XJ, 1987-90 use 83500202
 Diesel : XJ, 1984-90 use 83500202

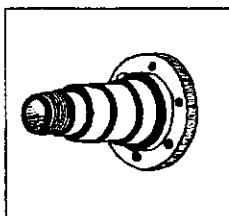

10.004

SPINDLE ASSY, Steering
 (with Seal, Bearing & Spacer)

6 Cyl : SJ, 1979 use J8128767
 6 Cyl : SJ, 1988-90 use J8128767
 8 Cyl : SJ, 1979-90 use J8128767

NOTE: 1. FOR LEFT HAND, 1982-84, WITH
 DISCONNECT AXLE USE J8134218.

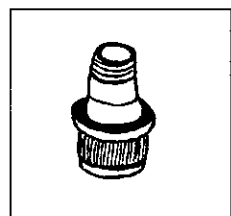

10.006

STUD, Steering Knuckle Ball (Upper)

6 Cyl : SJ, 1979-90 use J8122495
 8 Cyl : SJ, 1979-90 use J8122495

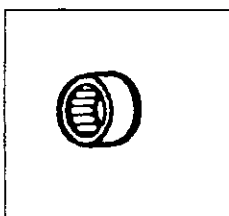

10.004

BEARING KIT, Steering Spindle

6 Cyl : SJ, 1979-90 use J8127356
 8 Cyl : SJ, 1979-90 use J8127356

NOTE: 1. KIT NOT AVAILABLE FOR USE WITH
 DISCONNECT AXLE. USE INDIVIDUAL COMPONENTS,
 INCLUDING 83500950 RETAINER.

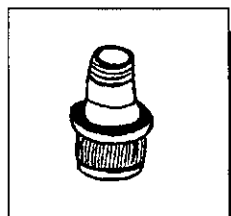

10.006

STUD, Steering Knuckle Ball (Lower)

6 Cyl : SJ, 1979-90 use J8122496
 8 Cyl : SJ, 1979-90 use J8122496

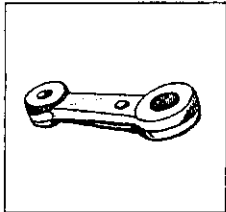

10.104

ARM, Steering Linkage Pitman
with Power Steering

6 Cyl : SJ, 1979-90 use J5352278
8 Cyl : SJ, 1979-90 use J5352278

4 Cyl : XJ, 1984-90 use 52000615
V6 Cyl : XJ, 1984-86 use 52000615
I6 Cyl : XJ, 1987-90 use 52000615
Diesel : XJ, 1984-90 use 52000615

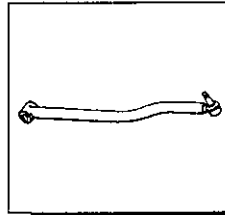

10.118

TRACK BAR

4 Cyl : XJ, 1984-90 use 52003918
V6 Cyl : XJ, 1984-86 use 52003918
I6 Cyl : XJ, 1987-90 use 52003918
Diesel : XJ, 1984-90 use 52003918

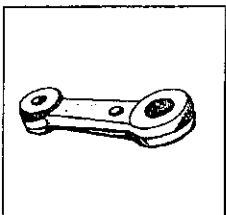

10.104

ARM, Steering Linkage Pitman
without Power Steering

6 Cyl : SJ, 1979-85 use J5352162
8 Cyl : SJ, 1979-85 use J5352162

4 Cyl : XJ, 1984-90 use 52000616
V6 Cyl : XJ, 1984-86 use 52000616
I6 Cyl : XJ, 1987-90 use 52000616
Diesel : XJ, 1984-90 use 52000616

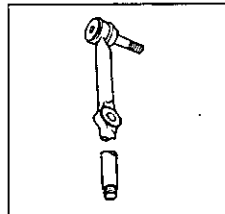

10.126

TIE ROD END ASSY, Steering
Arm to Steering Arm

6 Cyl : SJ, 1979-90 use J8124816¹
8 Cyl : SJ, 1979-90 use J8124816¹

4 Cyl : XJ, 1984-90 use 52000601²
V6 Cyl : XJ, 1984-86 use 52000601²
I6 Cyl : XJ, 1987-90 use 52000601²
Diesel : XJ, 1984-90 use 52000601²

NOTE: 1. THIS IS 46-1/2"; FOR J10 & J20 AND
CHEROKEE CHIEF (50-1/2") USE J8124823.
2. THIS IS 32-1/4".

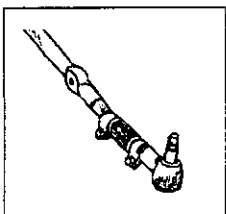

10.118

TIE ROD ASSY, Steering Arm to
Steering Arm (with Ends)

6 Cyl : SJ, 1979-90 use J5352665¹
8 Cyl : SJ, 1979-90 use J5352665¹

NOTE: 1. FOR J10 & J20 AND CHEROKEE CHIEF
USE J5352680.

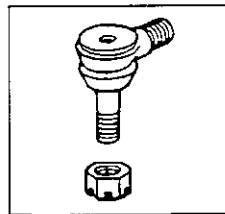

10.126

TIE ROD END ASSY, Steering
Arm to Steering Arm - Short

6 Cyl : SJ, 1979-90 use J8124817
8 Cyl : SJ, 1979-90 use J8124817

4 Cyl : XJ, 1984-90 use 52000599¹
V6 Cyl : XJ, 1984-86 use 52000599¹
I6 Cyl : XJ, 1987-90 use 52000599¹
Diesel : XJ, 1984-90 use 52000599¹

NOTE: 1. THIS IS FOR RIGHT SIDE.

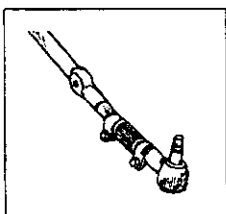

10.118

TIE ROD ASSY, Pitman Arm to
Steering Arm (with Ends)

6 Cyl : SJ, 1979-90 use J5352163¹
8 Cyl : SJ, 1979-90 use J5352163¹

4 Cyl : XJ, 1984-90 use 52000596²
V6 Cyl : XJ, 1984-86 use 52000596²
I6 Cyl : XJ, 1987-90 use 52000596²
Diesel : XJ, 1984-90 use 52000596²

NOTE: 1. FOR J10 & J20 AND CHEROKEE CHIEF
USE J5352421.
2. TUBE ONLY.

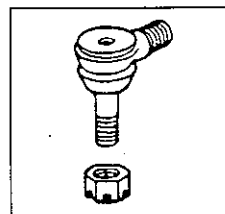

10.126

TIE ROD END ASSY, Pitman Arm
to Steering Arm - Left Hand Thread

6 Cyl : SJ, 1979-90 use J8123315¹
8 Cyl : SJ, 1979-90 use J8123315¹

4 Cyl : XJ, 1984-90 use 52000608²
V6 Cyl : XJ, 1984-86 use 52000608²
I6 Cyl : XJ, 1987-90 use 52000608²
Diesel : XJ, 1984-90 use 52000608²

NOTE: 1. THIS IS 21.88"; FOR J10 & J20
(23.88") USE J8123316.
2. THIS IS FOR LEFT SIDE.

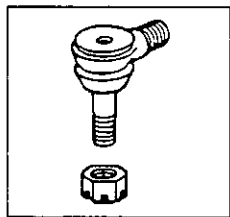

10.126

TIE ROD END ASSY, Pitman Arm
to Steering Arm - Right Hand Thread

6 Cyl : SJ, 1979-90 use J8123319¹
8 Cyl : SJ, 1979-90 use J8123319¹

4 Cyl : XJ, 1984-90 use 52000598
V6 Cyl : XJ, 1984-86 use 52000598
I6 Cyl : XJ, 1987-90 use 52000598
Diesel : XJ, 1984-90 use 52000598

NOTE: 1. THIS IS 3.75".

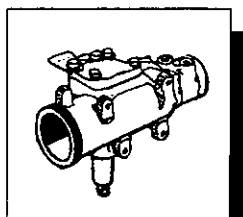

10.290

GEAR ASSY, Steering

Left Hand Drive - W/O Power Steering

6 Cyl : SJ, 1979-85 use J0994509
8 Cyl : SJ, 1979-85 use J0994509

4 Cyl : XJ, 1984-90 use 52000089
V6 Cyl : XJ, 1984-86 use 52000089
I6 Cyl : XJ, 1987-90 use 52000089
Diesel : XJ, 1984-90 use 52000089

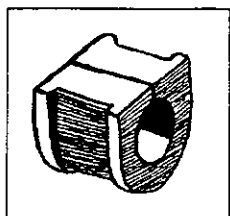

10.260

CUSHION, Front Suspension Sway
Stabilizer to Frame

6 Cyl : SJ, 1979-85 use J5355315¹
8 Cyl : SJ, 1979-85 use J5355315¹

4 Cyl : XJ, 1984-89 use 52001144
4 Cyl : XJ, 1990 use 52006495
V6 Cyl : XJ, 1984-86 use 52001144
I6 Cyl : XJ, 1987-89 use 52001144
I6 Cyl : XJ, 1990 use 52006495
Diesel : XJ, 1984-89 use 52001144
Diesel : XJ, 1990 use 52006495

NOTE: 1. FOR J20 USE J5352702.

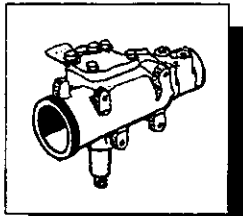

10.290

GEAR ASSY, Steering

Left Hand Drive - With Power Steering

6 Cyl : SJ, 1979 use J5359078¹
6 Cyl : SJ, 1980-85 use J5360093²
6 Cyl : SJ, 1986-89 use 52002085²
8 Cyl : SJ, 1979 use J5359078¹
8 Cyl : SJ, 1980-85 use J5360093²
8 Cyl : SJ, 1986-89 use 52002085²

4 Cyl : XJ, 1984-87 use 83502253³
4 Cyl : XJ, 1988-90 use 52002737
V6 Cyl : XJ, 1984-86 use 83502253³
I6 Cyl : XJ, 1987 use 83502253³
I6 Cyl : XJ, 1988-90 use 52002737
Diesel : XJ, 1984-87 use 83502253³
Diesel : XJ, 1988-90 use 52002737

NOTE: 1. FOR J20 USE J5359079.
2. FOR J20 USE J5360094.
3. WITH I.D. #ES USE 52002737.

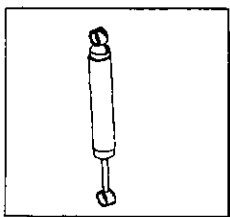

10.260

DAMPER, Steering (Shock Type)

6 Cyl : SJ, 1979-85 use J8129434
8 Cyl : SJ, 1979-85 use J8129434

4 Cyl : XJ, 1984-90 use 3236097HD
V6 Cyl : XJ, 1984-86 use 3236097HD
I6 Cyl : XJ, 1987-90 use 3236097HD
Diesel : XJ, 1984-90 use 3236097HD

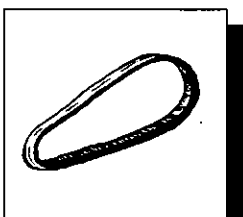

10.455

BELT, Power Steering Pump

6 Cyl : SJ, 1979-90 use J3226936
8 Cyl : SJ, 1979-90 use J3227692

4 Cyl : XJ, 1984-85 use J3226936
4 Cyl : XJ, 1986-90 use 53001120^{1,2}
V6 Cyl : XJ, 1984-86 use 53000830
I6 Cyl : XJ, 1987-90 use 53002899²
Diesel : XJ, 1984-90 use 53001773

NOTE: 1. WITHOUT AIR CONDITIONING USE 53002900.
2. THIS IS A COMPLETE SERPENTINE BELT.

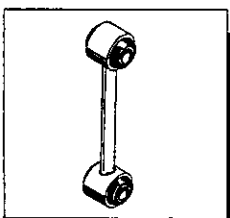

10.260

LINK, Front Suspension Sway
Stabilizer to Spring Tie Plate Connecting

6 Cyl : SJ, 1979-88 use J5355594¹
8 Cyl : SJ, 1979-88 use J5355594¹

4 Cyl : XJ, 1984-90 use 52003360
V6 Cyl : XJ, 1984-86 use 52003360
I6 Cyl : XJ, 1987-90 use 52003360
Diesel : XJ, 1984-90 use 52003360

NOTE: 1. FOR J20 USE J5352788.

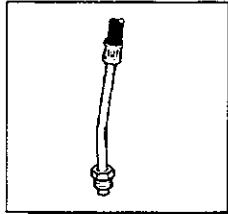

HOSE, Power Steering Pump to Steering Gear Pressure

6 Cyl : SJ, 1979 use J5359283
 6 Cyl : SJ, 1980-90 use 52003769
 8 Cyl : SJ, 1979 use J5355718
 8 Cyl : SJ, 1980-90 use 52003079

10.470

4 Cyl : XJ, 1984-85 use 83504380
 4 Cyl : XJ, 1986 use 52002719
 4 Cyl : XJ, 1987-90 use 52003625
 V6 Cyl : XJ, 1984-86 use 83504380
 16 Cyl : XJ, 1987-90 use 52003627
 Diesel : XJ, 1984-86 use 52001604
 Diesel : XJ, 1987 use 52003212

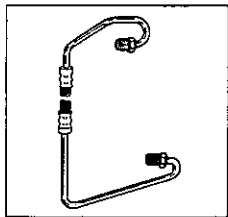

HOSE, Power Steering Pump to Steering Gear Pressure

6 Cyl : SJ, 1979 use J5355893
 6 Cyl : SJ, 1980-89 use J5370025
 8 Cyl : SJ, 1979 use J5355767
 8 Cyl : SJ, 1980-89 use J5370023

10.470

4 Cyl : XJ, 1984-85 use 52001140
 4 Cyl : XJ, 1986 use 52002720
 4 Cyl : XJ, 1987-90 use 52003135
 V6 Cyl : XJ, 1984-86 use 52001140
 16 Cyl : XJ, 1987-90 use 52003782
 Diesel : XJ, 1984-86 use 52001606
 Diesel : XJ, 1987 use 52003140

NOTE: 1. WITHOUT AIR CONDITIONING USE 52001231.



SPRING ASSY, Front Leaf
(without Bushings)

5 Leaf (Light)

6 Cyl : SJ, 1979-90 use J5362950
8 Cyl : SJ, 1981-90 use J5362950

11.070

6 Leaf (Light & Heavy)

6 Cyl : SJ, 1979-90 use J5362949
8 Cyl : SJ, 1979-90 use J5362949

7 Leaf (Light)

6 Cyl : SJ, 1979-80 use J5359357¹
6 Cyl : SJ, 1981-90 use J5362954²
8 Cyl : SJ, 1979-80 use J5359268¹
8 Cyl : SJ, 1981-90 use J5362953²

NOTE: 1. FOR J20 USE J5359023.
2. FOR J20 USE J5362951.

7 Leaf (Heavy)

6 Cyl : SJ, 1979-80 use J5359023
6 Cyl : SJ, 1981-90 use J5362952
8 Cyl : SJ, 1979-80 use J5359023
8 Cyl : SJ, 1981-90 use J5362952

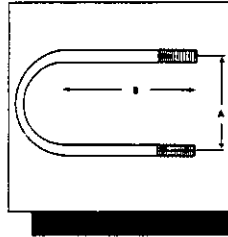

U - BOLT, Front Spring - SJ only

Length (B) = 5.50" , Width (A) = 3.40"
1979-86 use J8129475
Length (B) = 6.00" , Width (A) = 3.60"
1979-86 use J8129476
Length (B) = 6.00" , Width (A) = 4.40"
1979-86 use J5363631
Length (B) = 6.75" , Width (A) = 4.20"
1979-90 use J8129474

11.088

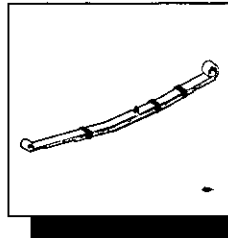

SPRING ASSY, Rear Leaf
(without Bushings)

2 Leaf (Light - Heavy)

6 Cyl : SJ, 1979-90 use J5355415¹
8 Cyl : SJ, 1979-90 use J5355415¹

NOTE: 1. FOR J10 & J20 ONLY.

11.100

3 Leaf (Light - Heavy)

6 Cyl : SJ, 1979-82 use J5355414¹
8 Cyl : SJ, 1979-82 use J5355414¹

NOTE: 1. FOR J20 ONLY.

4 Leaf (Light)

6 Cyl : SJ, 1979-90 use J5355576¹
8 Cyl : SJ, 1979-90 use J5355576¹

NOTE: 1. FOR J10 ONLY.

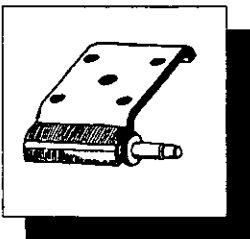

PLATE, Front Leaf Spring to Axle Tie

Left

6 Cyl : SJ, 1979 use J5359225
6 Cyl : SJ, 1980-86 use J5359582
6 Cyl : SJ, 1987-90 use J5359585
8 Cyl : SJ, 1979 use J5359225
8 Cyl : SJ, 1980-86 use J5359582
8 Cyl : SJ, 1987-90 use J5359585

11.088

Right

6 Cyl : SJ, 1979 use J5359224
6 Cyl : SJ, 1980-86 use J5359583
6 Cyl : SJ, 1987-90 use J5359584
8 Cyl : SJ, 1979 use J5359224
8 Cyl : SJ, 1980-86 use J5359583
8 Cyl : SJ, 1987-90 use J5359584

5 Leaf (Light)

6 Cyl : SJ, 1979-80 use J5358982¹
6 Cyl : SJ, 1981-85 use J5362955¹
8 Cyl : SJ, 1979-80 use J5358982¹
8 Cyl : SJ, 1981-85 use J5362955¹

NOTE: 1. FOR WAGONEER, CHEROKEE & J10 ONLY.

5 Leaf (Heavy)

6 Cyl : SJ, 1979-90 use J5362956¹
8 Cyl : SJ, 1979-90 use J5362956¹

NOTE: 1. FOR WAGONEER, CHEROKEE & J10 ONLY.

6 Leaf

6 Cyl : SJ, 1981-90 use J5364156¹
8 Cyl : SJ, 1981-90 use J5364156¹

NOTE: 1. FOR J10 & J20 ONLY.

9 Leaf

6 Cyl : SJ, 1981-90 use J5364155 1
 8 Cyl : SJ, 1981-90 use J5364155 1

NOTE: 1. FOR J10 & J20 ONLY.

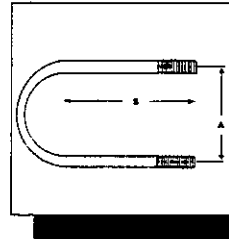

U - BOLT, Rear Spring

SJ :

Length (B) = 5.50" , 1979-85 use J5352088
 Length (B) = 5.00" , 1979-85 use J5352090
 Length (B) = 6.20" , 1979-90 use J8129475
 Length (B) = 6.70" , 1979-90 use J8130371
 Length (B) = 7.70" , 1979-90 use J5364244

XJ :

Width (A) = 77mm, 3.03" 1984-89 use 52000232
 Width (A) = 77mm, 3.27" 1990 use 52006440
 Width (A) = 83mm, 3.03" 1986-89 use 52003499

MJ :

Width (A) = 80mm, 3.15" 1986-90 use 52002885
 Width (A) = 85mm, 3.35" 1987 use 52002886
 Width (A) = 85mm, 3.35" 1988-89 use 52003678
 Width (A) = 85mm, 3.35" 1990 use 52003996

11.132

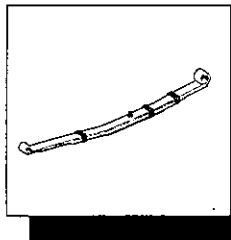

SPRING ASSY, Rear Leaf - XJ
 (without Bushings) - Standard Duty

Coded LB, 1984-90 use 52000050
 Coded LC, 1984-90 use 52000051
 Coded LN, 1984-90 use 52000706

11.100

SPRING ASSY, Rear Leaf - MJ
 (without Bushings) - Standard Duty

Coded RB, 1988-89 use 52002312
 Coded RD, 1988-89 use 52001240
 Coded RE, 1988-89 use 52002351
 Coded RF, 1988-89 use 52001824
 Coded RG, 1988-89 use 52002350
 Coded RB, 1990 use 52006448
 Coded RD, 1990 use 52006444
 Coded RE, 1990 use 52006446
 Coded RF, 1990 use 52006445
 Coded RG, 1990 use 52006447

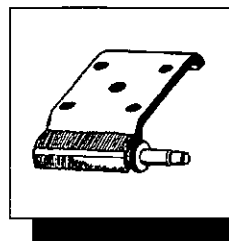

PLATE, Rear Leaf Spring to Axle
 U-Bolt Tie

11.136

SJ	1979-90		J5252087
J20	1979-90		J5352091
XJ	1984-89		52003500
XJ	1990		52006449
MJ	1987-89	Right, 7' Box	52001832
MJ	1987-89	Left, 7' Box	52001833
MJ	1990	Right, 7' Box	52004844
MJ	1990	Left, 7' Box	52004845
MJ	1987-89	Right, 6' Box	52001833
MJ	1987-89	Left, 6' Box	52001832
MJ	1990	Right, 6' Box	52004845
MJ	1990	Left, 6' Box	52004844

SPRING ASSY, Rear Leaf - XJ
 (without Bushings) - Heavy Duty

Coded LK, 1984-90 use 52000544
 Coded LL, 1984-90 use 52000545
 Coded LM, 1984-90 use 52000707
 Coded LS, 1984-90 use 52002390
 Coded LT, 1984-90 use 52002392

SPRING ASSY, Rear Leaf - MJ
 (without Bushings) - Heavy Duty

Coded SD, 1988-90 use 53003676

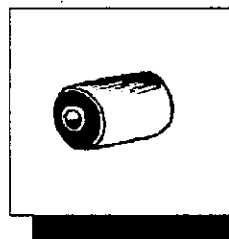

BUSHING, Front Spring - Front

6 Cyl : SJ, 1979-90 use J0944870
 8 Cyl : SJ, 1979-90 use J0944870

11.144

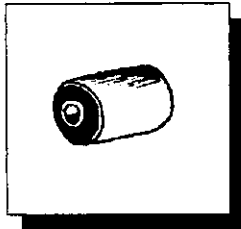

11.144

BUSHING, Front Spring - Rear

6 Cyl : SJ, 1979-90 use J5355369 ¹
8 Cyl : SJ, 1979-90 use J5355369 ¹

NOTE: 1. WITH 2" O.D. X 2-15/16" USE J5358985.

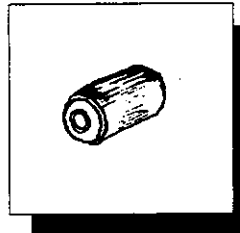

11.170

BUSHING, Leaf Spring Shackle Front & Rear

6 Cyl : SJ, 1979-90 use J5352079
8 Cyl : SJ, 1979-90 use J5352079

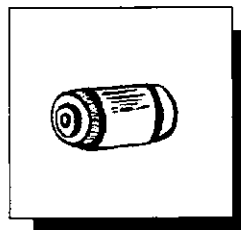

11.144

BUSHING, Rear Spring - Front

6 Cyl : SJ, 1980-90 use J5355369 ¹
8 Cyl : SJ, 1980-90 use J5355369 ¹

4 Cyl : XJ, 1984-90 use 52000503 ²
V6 Cyl : XJ, 1984-86 use 52000503 ²
I6 Cyl : XJ, 1987-90 use 52000503 ²
Diesel : XJ, 1984-90 use 52000503 ²

NOTE: 1. WITH 2" O.D. X 2-15/16" USE J5358985.
2. FOR MJ USE 52000876

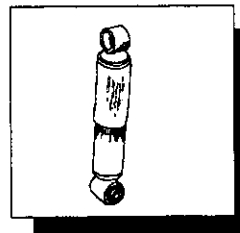

11.200

SHOCK ASSY, Front - Light

4 Cyl : XJ, 1984-90 use 83500313
V6 Cyl : XJ, 1984-86 use 83500313
I6 Cyl : XJ, 1987-90 use 83500313
Diesel : XJ, 1984-90 use 83500313

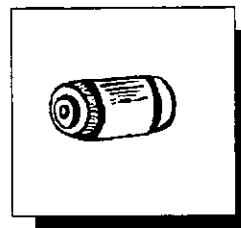

11.144

BUSHING, Rear Spring - Rear

6 Cyl : SJ, 1980-90 use J0944870
8 Cyl : SJ, 1980-90 use J0944870

4 Cyl : XJ, 1984-90 use 52000504
V6 Cyl : XJ, 1984-86 use 52000504
I6 Cyl : XJ, 1987-90 use 52000504
Diesel : XJ, 1984-90 use 52000504

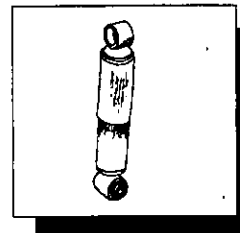

11.200

SHOCK ASSY, Front - Standard

6 Cyl : SJ, 1979-85 use J8133732 ¹
6 Cyl : SJ, 1986-90 use 83501877
8 Cyl : SJ, 1979-85 use J8133732 ¹
8 Cyl : SJ, 1986-90 use 83501877

4 Cyl : XJ, 1984-90 use 83500312 ²
V6 Cyl : XJ, 1984-86 use 83500312 ²
I6 Cyl : XJ, 1987-90 use 83500312 ²
Diesel : XJ, 1984-90 use 83500312 ²

NOTE: 1. FOR "SOFT RIDE" USE J8133734.
2. FOR COMANCHE USE 83502509.

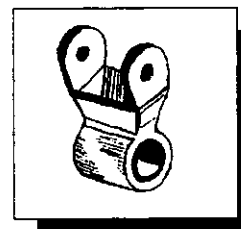

11.170

SHACKLE, Front & Rear Leaf Spring

6 Cyl : SJ, 1979-90 use J5352863 ¹
8 Cyl : SJ, 1979-90 use J5352863 ¹

4 Cyl : XJ, 1984-90 use 52000507 ²
V6 Cyl : XJ, 1984-86 use 52000507 ²
I6 Cyl : XJ, 1987-90 use 52000507 ²
Diesel : XJ, 1984-90 use 52000507 ²

NOTE: 1. FOR J20 USE J5352251.
2. FOR COMANCHE USE 52001828.

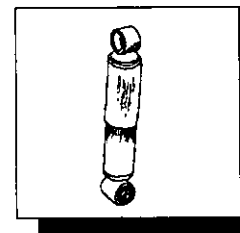

11.200

SHOCK ASSY, Front - Heavy

6 Cyl : SJ, 1979-85 use J8129467
6 Cyl : SJ, 1986-90 use 83503694 ¹
8 Cyl : SJ, 1979-85 use J8129467
8 Cyl : SJ, 1986-90 use 83503694 ¹

4 Cyl : XJ, 1984-90 use 83500314 ²
V6 Cyl : XJ, 1984-86 use 83500314 ²
I6 Cyl : XJ, 1987-90 use 83500314 ²
Diesel : XJ, 1984-90 use 83500314 ²

NOTE: 1. FOR J10 & J20 USE J8129467.
2. FOR COMANCHE USE 83502510. FOR XJ HEAVY DUTY OFF-ROAD PACKAGE USE 83504211.

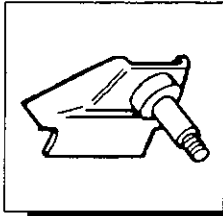

BRACKET, Front Shock to Frame

Left

6 Cyl : SJ, 1979-90 use J5364229
8 Cyl : SJ, 1979-90 use J5364229

Right

6 Cyl : SJ, 1979-90 use J5364228
8 Cyl : SJ, 1979-90 use J5364228

11.201

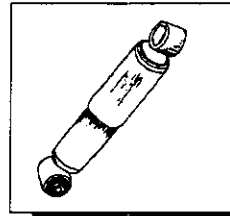

**SHOCK ASSY, Rear Spring
(w/ Attaching Parts) - Standard**

6 Cyl : SJ, 1981-84 use J8133733 ¹
6 Cyl : SJ, 1985-90 use 83501878 ³
8 Cyl : SJ, 1981-84 use J8133733 ¹
8 Cyl : SJ, 1985-90 use 83501878 ³

11.220

4 Cyl : XJ, 1984-85 use 83500315
4 Cyl : XJ, 1986-90 use 83501159 ²
V6 Cyl : XJ, 1984-85 use 83500315
V6 Cyl : XJ, 1986 use 83501159 ²
I6 Cyl : XJ, 1987-90 use 83501159 ²
Diesel : XJ, 1984-85 use 83500315
Diesel : XJ, 1986-90 use 83501159 ²

NOTE: 1. FOR "SOFT RIDE" USE J8133735.
2. FOR COMANCHE:
CODED 8952000950 USE 83502512.
CODED 8952001237 USE 83502513.
CODED 8952002307 USE 83503449.
CODED 8952002672 USE 83503450.
3. FOR J10 & J20 USE J8133733.

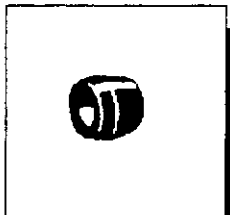

**BUSHING, Front & Rear Shock
Absorber Mounting**

6 Cyl : SJ, 1979-90 use J0637936
8 Cyl : SJ, 1979-90 use J0637936

11.202

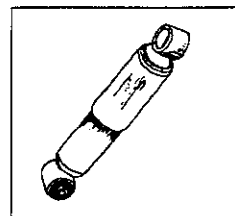

**SHOCK ASSY, Rear Spring
(w/ Attaching Parts) - Heavy**

6 Cyl : SJ, 1981-85 use J8133292 ¹
6 Cyl : SJ, 1986-89 use 83503693 ²
8 Cyl : SJ, 1981-85 use J8133292 ¹
8 Cyl : SJ, 1986-89 use 83503693 ²

11.220

4 Cyl : XJ, 1984-85 use 83500317
4 Cyl : XJ, 1986-90 use 83501161 ³
V6 Cyl : XJ, 1984-85 use 83500317
V6 Cyl : XJ, 1986 use 83501161 ³
I6 Cyl : XJ, 1987-90 use 83501161 ³
Diesel : XJ, 1984-85 use 83500317
Diesel : XJ, 1986-90 use 83501161 ³

NOTE: 1. FOR J10 & J20, 1979-80 USE J5352654. FOR J20, 1981-85, USE J8134106. FOR J10 WITH 131" WHEELBASE USE J8134106.
2. FOR J20 USE J8133293.
3. FOR XJ CODED 8952004525, 1989, USE 83506307. FOR XJ HEAVY DUTY OFF-ROAD PACKAGE USE 83504212.
FOR COMANCHE:
CODED 8952002787 USE 83502514.
CODED 8952003287 USE 83503448.

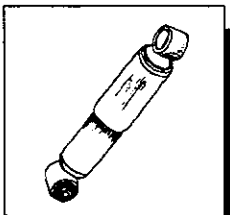

**SHOCK ASSY, Rear Spring
(w/ Attaching Parts) - Light**

4 Cyl : XJ, 1984-85 use 83500316
4 Cyl : XJ, 1986-90 use 83501160
V6 Cyl : XJ, 1984-85 use 83500316
V6 Cyl : XJ, 1986 use 83501160
I6 Cyl : XJ, 1987-90 use 83501160
Diesel : XJ, 1984-85 use 83500316
Diesel : XJ, 1986-90 use 83501160

11.220

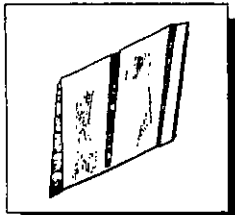

HOOD ASSY

6 Cyl : SJ, 1979-86 use J5758030
 6 Cyl : SJ, 1987-90 use 83506200
 8 Cyl : SJ, 1979-86 use J5758030
 8 Cyl : SJ, 1987-90 use 83506200

4 Cyl : XJ, 1984-86 use 57000051
 4 Cyl : XJ, 1987-90 use 57001769
 V6 Cyl : XJ, 1984-86 use 57000051
 16 Cyl : XJ, 1987-90 use 57001769
 Diesel : XJ, 1984-86 use 57000051
 Diesel : XJ, 1987-90 use 57001769

12.001

(CAPA)

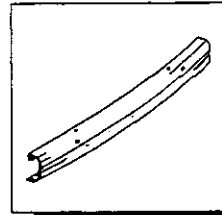

RAIL, Front Bumper (Black)

ALL XJ, 1984-90, use 52000185

12.168

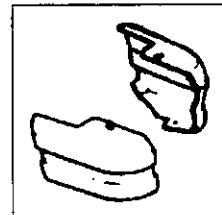

CAP, Front Bumper Rail

ALL XJ, 1984-90, **Right** use 52000178
 ALL XJ, 1984-90, **Left** use 52000179

12.168

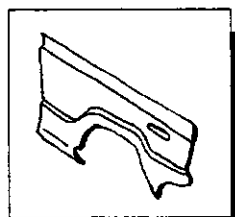

FENDER ASSY, Front - Left

6 Cyl : SJ, 1979-90 use J5465037
 8 Cyl : SJ, 1979-90 use J5465037

4 Cyl : XJ, 1984-90 use 57000067
 V6 Cyl : XJ, 1984-86 use 57000067
 16 Cyl : XJ, 1987-90 use 57000067
 Diesel : XJ, 1984-90 use 57000067

12.075

(CAPA)

NOTE: 1. FOR J10 & J20 USE J5465039.

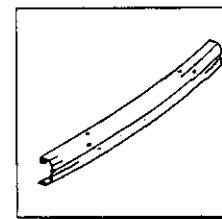

RAIL, Rear Bumper (Black)

ALL XJ, 1984-90, use 55026257

12.168

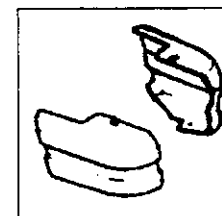

CAP, Rear Bumper Rail

ALL XJ, 1984-90, **Right** use 55022076
 ALL XJ, 1984-90, **Left** use 55022077

12.168

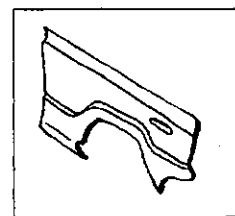

FENDER ASSY, Front - Right

6 Cyl : SJ, 1979-90 use J5465038
 8 Cyl : SJ, 1979-90 use J5465038

4 Cyl : XJ, 1984-90 use 57000066
 V6 Cyl : XJ, 1984-86 use 57000066
 16 Cyl : XJ, 1987-90 use 57000066
 Diesel : XJ, 1984-90 use 57000066

12.075

(CAPA)

NOTE: 1. FOR J10 & J20 USE J5465040.

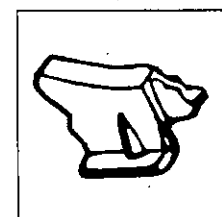

BRACKET, Rear Bumper Mounting

ALL XJ, 1984-90, use 55026265

12.168

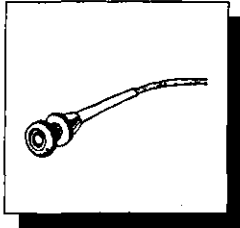

13.017

CABLE, Temperature Control

6 Cyl : SJ, 1979-85 use J5758073
 6 Cyl : SJ, 1986-90 use 56003524
 8 Cyl : SJ, 1979-85 use J5758073
 8 Cyl : SJ, 1986-90 use 56003524

4 Cyl : XJ, 1984-87 use 56000144
 4 Cyl : XJ, 1988-90 use 56003542
 V6 Cyl : XJ, 1984-86 use 56000144
 I6 Cyl : XJ, 1987 use 56000144
 I6 Cyl : XJ, 1988-90 use 56003542
 Diesel : XJ, 1984-87 use 56000144
 Diesel : XJ, 1988-90 use 56003542

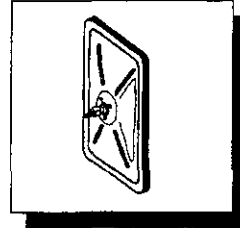

15.270

MIRROR HEAD, Outside Rear View
 Square - W/O Arm & Bracket

6 Cyl : SJ, 1979-81 use J0984032
 8 Cyl : SJ, 1979-81 use J0984032

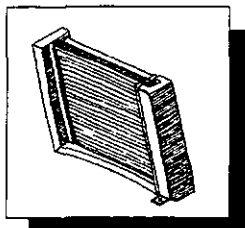

13.028

CORE, Heater

6 Cyl : SJ, 1979-90 use J8128784
 8 Cyl : SJ, 1979-90 use J8128784

4 Cyl : XJ, 1984-90 use 56000049
 V6 Cyl : XJ, 1984-86 use 56000049
 I6 Cyl : XJ, 1987-90 use 56000049
 Diesel : XJ, 1984-90 use 56001321

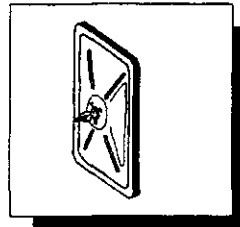

15.270

MIRROR HEAD, Outside Rear View
 used with Tripod Support; 7-1/2" x 10-1/2"

6 Cyl : SJ, 1979-90 use J8122825
 8 Cyl : SJ, 1979-90 use J8122825

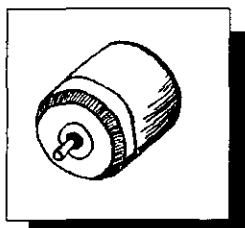

13.072

MOTOR, Heater & Defroster

6 Cyl : SJ, 1979-90 use J8128778
 8 Cyl : SJ, 1979-90 use J8128778

4 Cyl : XJ, 1984-87 use 56000173
 4 Cyl : XJ, 1988-90 use 56002858
 V6 Cyl : XJ, 1984-86 use 56000173
 I6 Cyl : XJ, 1987 use 56000173
 I6 Cyl : XJ, 1988-90 use 56002858
 Diesel : XJ, 1984-87 use 56000173
 Diesel : XJ, 1988-90 use 56002858

TRANSFER CASE

<u>YEAR</u>	<u>APPLICATION</u>	<u>MODEL</u>	<u>PAGE</u>
1979-90	SJ	208	TC3
1980-86	SJ	219	TC5
1981-90	SJ	228, 229	TC7
1984-90	XJ	228, 229	TC7
1984-86	XJ	207	TC11
1987-90	XJ	231	TC11
1987-90	XJ	242	TC13

TRANSFER CASE: MODEL 208

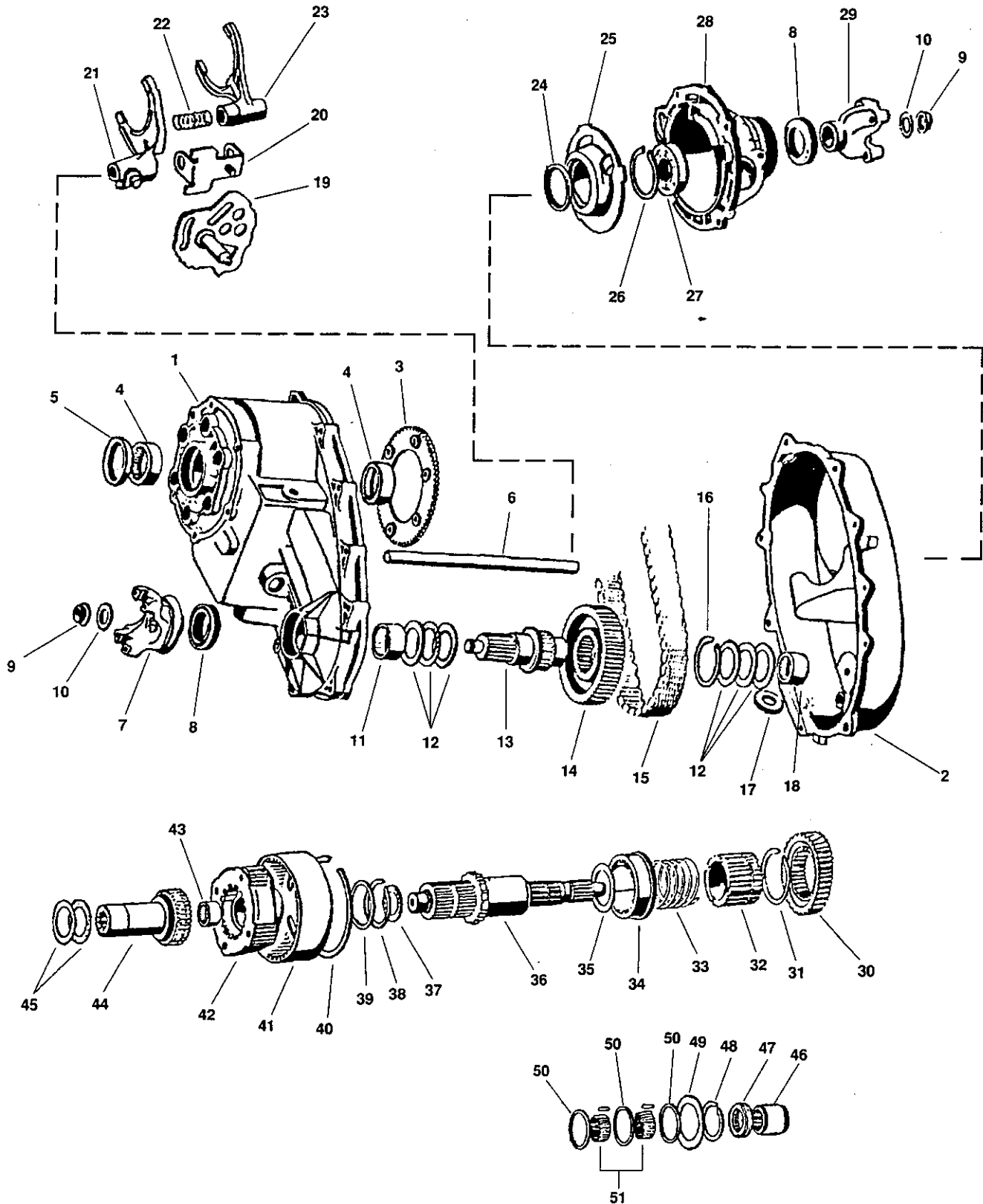

SJ - WAGONEER : 1979-1983
 GRAND WAGONEER : 1984-1990
 CHEROKEE : 1979-1983
 J10, J20 : 1979-1990

XJ - WAGONEER : 1984-1990
 CHEROKEE : 1984-1990
 COMANCHE : 1984-1990
 MJ - COMANCHE : 1984-1990

TRANSFER CASE: MODEL 208

<u>REFERENCE NUMBER</u>	<u>DESCRIPTION</u>	<u>1979-82</u>	<u>1983-86</u>	<u>1987-90</u>
1	CASE, front half	8130867	8130867	8130867
2	CASE, rear half	8130978	8130978	8130978
3	PLATE, low range lockout	8130873	8130873	8130873
4	BEARING, input shaft	8130868	8130868	8130868
5	SEAL, input shaft oil	8130870	8130870	5359457
6	RAIL, shift	8130822	8130822	8130822
7	YOKE, front output	8130818	8130818	8130818
8	SEAL, output oil	8130808	8130808	83505290
9	NUT	8130816	8130816	8130816
10	WASHER, seal	8130815	8130815	8130815
11	BEARING, front output shaft	8130869	8130869	8130869
12	BEARING ASSY, front output shaft	8130819	8130819	8130819
13	SHAFT, front output	8130976	8130976	8130976
14	SPROCKET, driven	8130975	8130975	8130975
15	CHAIN	8130977	8130977	8130977
16	RING, retaining	8130802	8130802	8130802
17	MAGNET	8130823	8130823	8130823
18	BEARING, front output shaft	8130836	8130836	8130836
19	SECTOR, range	8130820	8130820	8130820
20	BRACKET, mode	8130821	8130821	8130821
21	FORK, range	8130858	83500260	83500260
22	SPRING, mode fork	8130876	8130876	8130876
23	FORK, mode	8130851	8130851	8130851
24	SEAL, pump housing	8130982	8130982	8130982
25	HOUSING, pump	8130981	8130981	8130981
26	RING, retaining	8134411	8134411	8134411
27	BEARING, rear output rear	8130807	8136626	8136626
28	RETAINER, rear bearing	8130983	8130983	8130983
29	YOKE, rear	8130817	8130817	83503578
30	SPROCKET, drive	8130968	8130968	8130968
31	RING, sprocket stop	8130970	8130970	8130970
32	CARRIER, sprocket	8130969	8134541	8134541
33	SPRING, mode	83501437	83501437	83501437
34	CLUTCH, mode	8134545	83510094	83510094
35	WASHER, thrust	8130967	8130967	8130967
36	MAINSHAFT KIT	8130871	83510093	83510093
37	BEARING, mainshaft thrust	8130879	8130879	8130879
38	RING, retaining	8130866	8130866	8130866
39	WASHER, thrust	8130865	83500258	83500258
40	SNAP RING	8134454	8134454	8134454
41	GEAR ASSY, annulus	8130864	83500259	83500259
42	BEAR ASSY, planetary	8130862	8130862	8130862
43	BEARING, input	8130878	8130878	8130878
44	GEAR ASSY, input	8130877	8130877	8130877 ✱
45	BEARING KIT, input thrust	8130875	83502717	83502717
46	GEAR, speedometer drive	8130827	8130827	8130827
47	PUMP, oil	8130826	8130826	8130826
48	RING, retaining	8130974	8130974	8130974
49	WASHER, thrust	8134130	8134130	8134130
50	SPACER	8130971	8130971	8130971
51	ROLLER BEARING	8130972	8130972	8130972

✱ FOR J-20 TRUCK USE J8132818.

TRANSFER CASE: MODEL 219

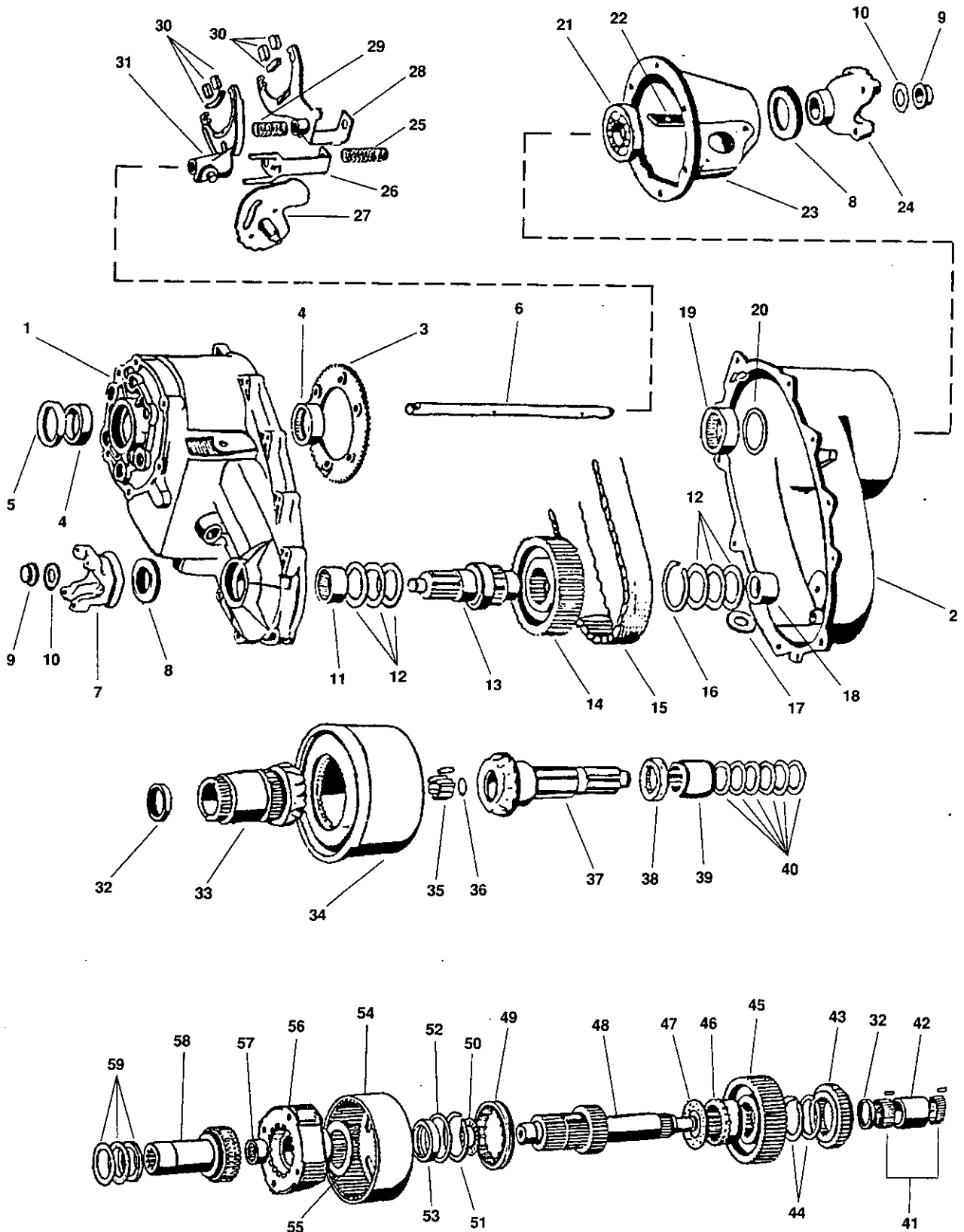

SJ - WAGONEER : 1979-1983
 GRAND WAGONEER : 1984-1990
 CHEROKEE : 1979-1983
 J10, J20 : 1979-1990

XJ - WAGONEER : 1984-1990
 CHEROKEE : 1984-1990
 COMANCHE : 1984-1990
 MJ - COMANCHE : 1984-1990

TRANSFER CASE: MODEL 219

REFERENCE			REFERENCE		
NUMBER	DESCRIPTION	PART #	NUMBER	DESCRIPTION	PART #
1	CASE, front half	8130867	51	RING, retaining	8130866
2	CASE, rear half	8130833	52	WASHER, thrust	8130865
3	PLATE, lockout	8130873	53	BUSHING, annulus	8133677
4	BEARING, input shaft	8130868	54	GEAR ASSY, annulus	8130864
5	SEAL, input shaft oil	8130870	55	WASHER, input gear thrust	8130863
6	RAIL, shift	8130838	56	GEAR ASSY, planetary	8130862
7	YOKE, front output	8130818	57	BEARING, input	8130878
8	SEAL, output oil	8130808	58	GEAR ASSY, input	8130877
9	NUT	8130816	59	BEARING KIT, input thrust	8130875 *
10	WASHER, seal	8130815			
11	BEARING, front output shaft	8130869			
12	BEARING ASSY, front output shaft	8130819			
13	SHAFT, front output	8130850			
14	SPROCKET, drive & driven	8130849			
15	CHAIN	8130831			
16	RING, retaining	8130802		* - WITH TAG # 8953001346 USE PART # 83500382.	
17	MAGNET	8130823			
18	BEARING, front output shaft rear	8130836			
19	BEARING, rear output inner	8130835			
20	WASHER, rear output inner brg.	8130834			
21	BEARING, rear output outer	8130807			
22	SEAL, vent chamber	8130809			
23	RETAINER, rear	8130806			
24	YOKE ASSY, rear	8130817			
25	SPRING, mode bracket	8130839			
26	BRACKET, mode	8130837			
27	SECTOR, range	8130852			
28	FORK, front mode	8130860			
29	SPRING, front mode fork	8130861			
30	PAD KIT	8130859			
31	FORK, range	8130858			
32	SPACER	8130848			
33	GEAR, side	8130845			
34	VISCOUS COUPLING	8130800			
35	ROLLER, pilot bearing	8130804			
36	SEAL, "O" ring	8130843			
37	SHAFT, rear output	8130803			
38	PUMP, oil	8133645			
39	GEAR, speedometer drive	8130827			
40	SHIM KIT	8130828			
41	ROLLER, side gear	8130846			
42	SPACER	8130847			
43	GEAR, viscous clutch	8130801			
44	RING, retaining	8130802			
45	SPROCKET, drive & driven	8130849			
46	GEAR, mode clutch side	8130841			
47	WASHER, mainshaft thrust	8130844			
48	MAINSHAFT	8130842			
49	SLEEVE, front sliding mode	8130840			
50	BEARING, mainshaft thrust	8130879			

TRANSFER CASE: MODEL 229 (1981-85); MODEL 228 (1986)

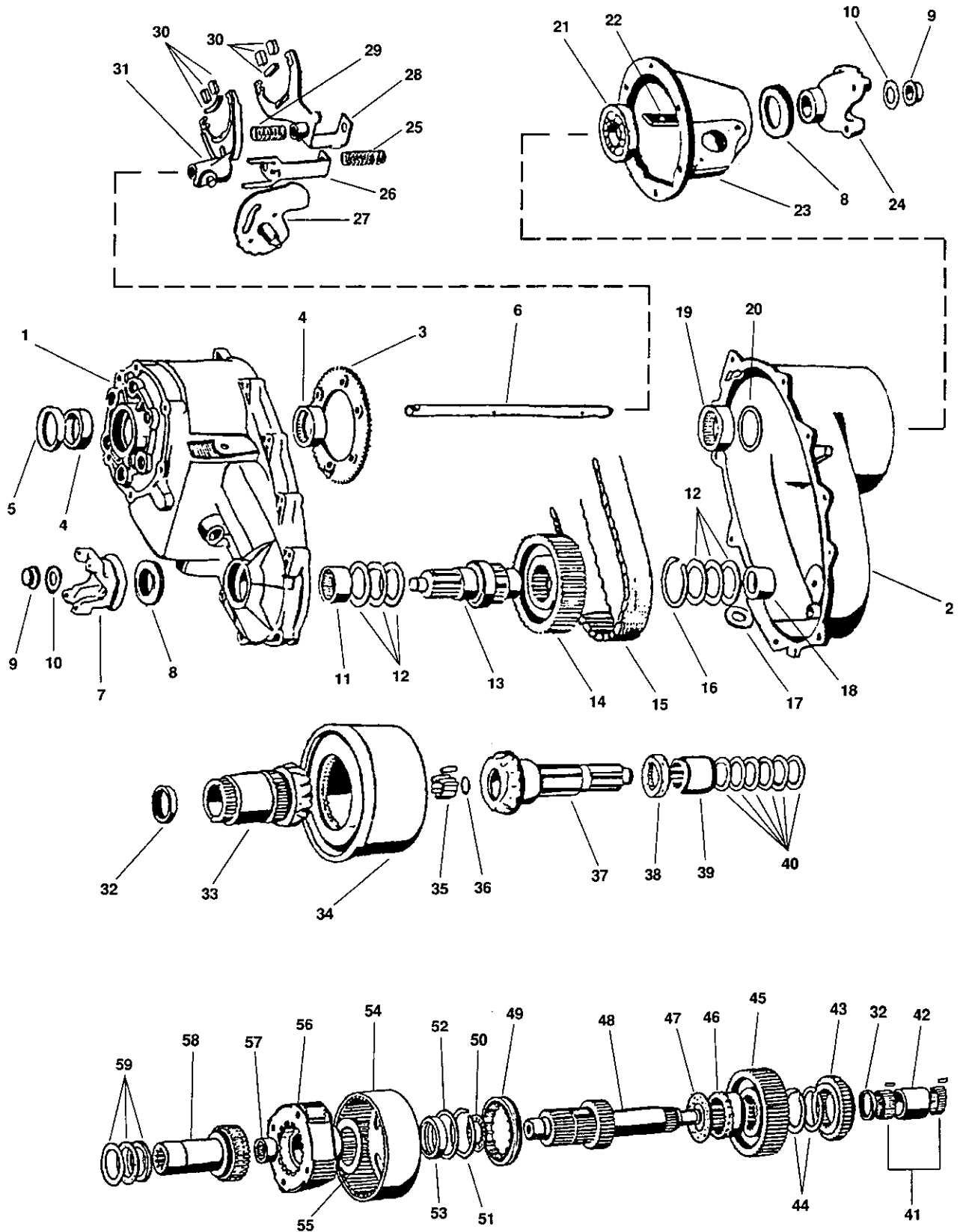

TRANSFER CASE: MODEL 229 (1981-85); MODEL 228 (1986)

REFERENCE NUMBER	DESCRIPTION	229	228	229	229
		1981-85	1986	1987-89	1990
		SJ, XJ	SJ, XJ	SJ	SJ
1	CASE, front half	J8134278	J8134278	15608	15608
2	CASE, rear half	J8134271	83502613	83502613	83502613
3	PLATE, low range lockout	J8130873	J8130873	J8130873	4167931
4	BEARING, input shaft	J8130868	J8130868	J8130868	J8130868
5	SEAL, input shaft oil	J8130870	J8130870	J5359457	J5359457
6	RAIL	J8134281	83502612	83502612	83502612
6A	RAIL	J8134280	J8134280	J8134280	15619
7	YOKE, front	J8134272	J8134272	83503586	15286
8	SEAL	J8130810	J8130810	J8130810	J8130810
9	NUT	J8130816	J8130816	J8130816	J8130816
10	SEAL	J8130815	J8130815	J8130815	J8130815
11	BEARING	J8130869	J8130869	J8130869	4269186
12	BEARING ASSY	J8130819	J8130819	J8130819	15127
13	SHAFT, front output	J8130850	J8130850	J8130850	15336
14	SPROCKET, driven	J8130849	J8130849	J8130849	J8130849
15	CHAIN	J8130831	J8130831	J8130831	J8130831
16	RING, retaining	J8130802	J8130802	J8130802	4167891
17	MAGNET	J8130823	J8130823	J8130823	3681601
18	BEARING, front output rear	J8130836	J8130836	J8130836	4269183
19	BEARING, output shaft inner	J8133644	J8133644	J8133644	15462
20	SEAL	J8133643	J8133643	J8130982	J8130982
21	BEARING, output	J8130807	J8130807	J8130807	J8130807
22	SEAL, vent	J8133743	J8133743	J8133743	J8133743
23	RETAINER, rear	J8130806	J8130806	J8130806	13693
24	YOKE, rear	J8130817	J8130817	83503578	13775
25	SPRING	J8134286	J8134286	J8134286	J8134286
26	BRACKET ASSY	J8134407	J8134407	J8134407	J8134407
27	SECTOR, range	J8134277	J8134277	J8134277	15609
28	FORK ASSY, mode	J8134275	J8134275	J8134275	J8134275
29	SPRING	J8134284	J8134284	J8134284	J8134284
30	PAD KIT	J8134279	J8134279	J8134279	15866
31	FORK, range	J8134276	J8134276	J8134286	15618
32					
33	GEAR, side	J8131608	J8131608	J8131608	13836
34	VISCOUS, coupling assy.	J8130800	83502517	J8130800	13855
35	ROLLER BEARING	J8130804	J8130804	83503570	83503570
36	SEAL, "O" ring	J8130843	J8130843		
37	SHAFT, rear output	J8130803	J8130803	J8130803	13867
38	PUMP, oil	J8133645	J8133645	J8133645	4446463
39	GEAR, speedometer drive	J8133646	J8133646	J8133646	15461
40	SHIM KIT	J8130828	J8130828	J8130828	15128
41	ROLLER BEARING	J8130846	J8130846	83500288	83500288
42	SPACER	J8130847	J8130847	J8130847	15004
43	GEAR, viscous clutch	J8130801		J8130801	13854
44					
45	SPROCKET, drive	J8131610	15450	15450	15450
46	GEAR, side clutch	J8133633	J8133633	J8133633	J8133633
47	WASHER, mainshaft thrust	J8130844	J8130844	J8130844	13851

TRANSFER CASE: MODEL 229 (1981-85); MODEL 228 (1986)

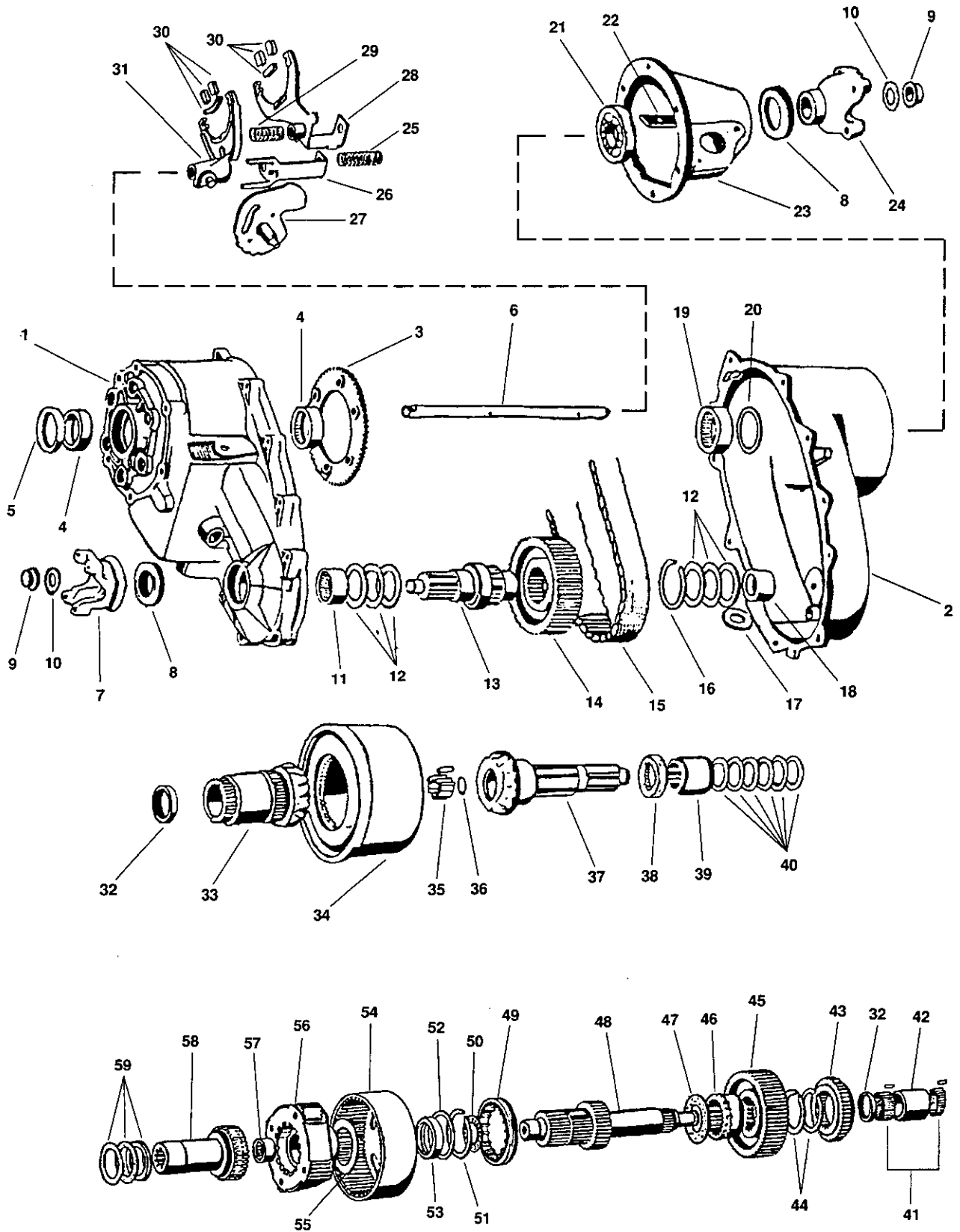

TRANSFER CASE: MODEL 229 (1981-85); MODEL 228 (1986)

REFERENCE NUMBER	DESCRIPTION	229	228	229	229
		1981-85	1986	1987-89	1990
		<u>SJ, XJ</u>	<u>SJ, XJ</u>	<u>SJ</u>	<u>SJ</u>
48	MAINSHAFT	J8134274	J8134274	J8134274	15636
49	SLEEVE	83502516	83502516	83502516	16111
49A	SLEEVE	83502611	83502611	83502611	16112
50	BEARING, thrust	J8130879	J8130879	J8130879	4269182
51	RING, retaining	J8130866	J8130866	J8130866	3821372
52	WASHER, thrust	J8130865	J8130865	J8130865	4167959
53	BUSHING, annulus	J8133677	J8133677	J8133677	13721
54	GEAR ASSY, annulus	J8130864	J8130864	J8130864	4167954
55	WASHER	J8130863	J8130863	J8130863	J8130863
56	GEAR ASSY, planetary	83500383	83500383	83500383	4329198
57	BEARING, input	J8130878	J8130878	J8130878	4269187
58	SHAFT, input	83500492	83500492	83500492	15786
59	BEARING ASSY, input thrust	83500382	83500382	83500382	16027

TRANSFER CASE: MODEL 207 & 231

231

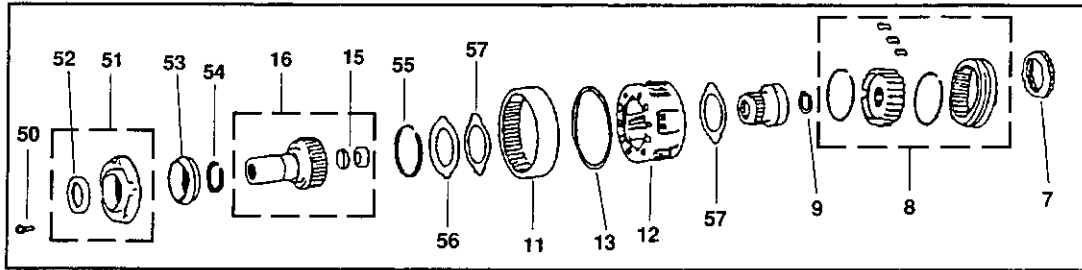

207

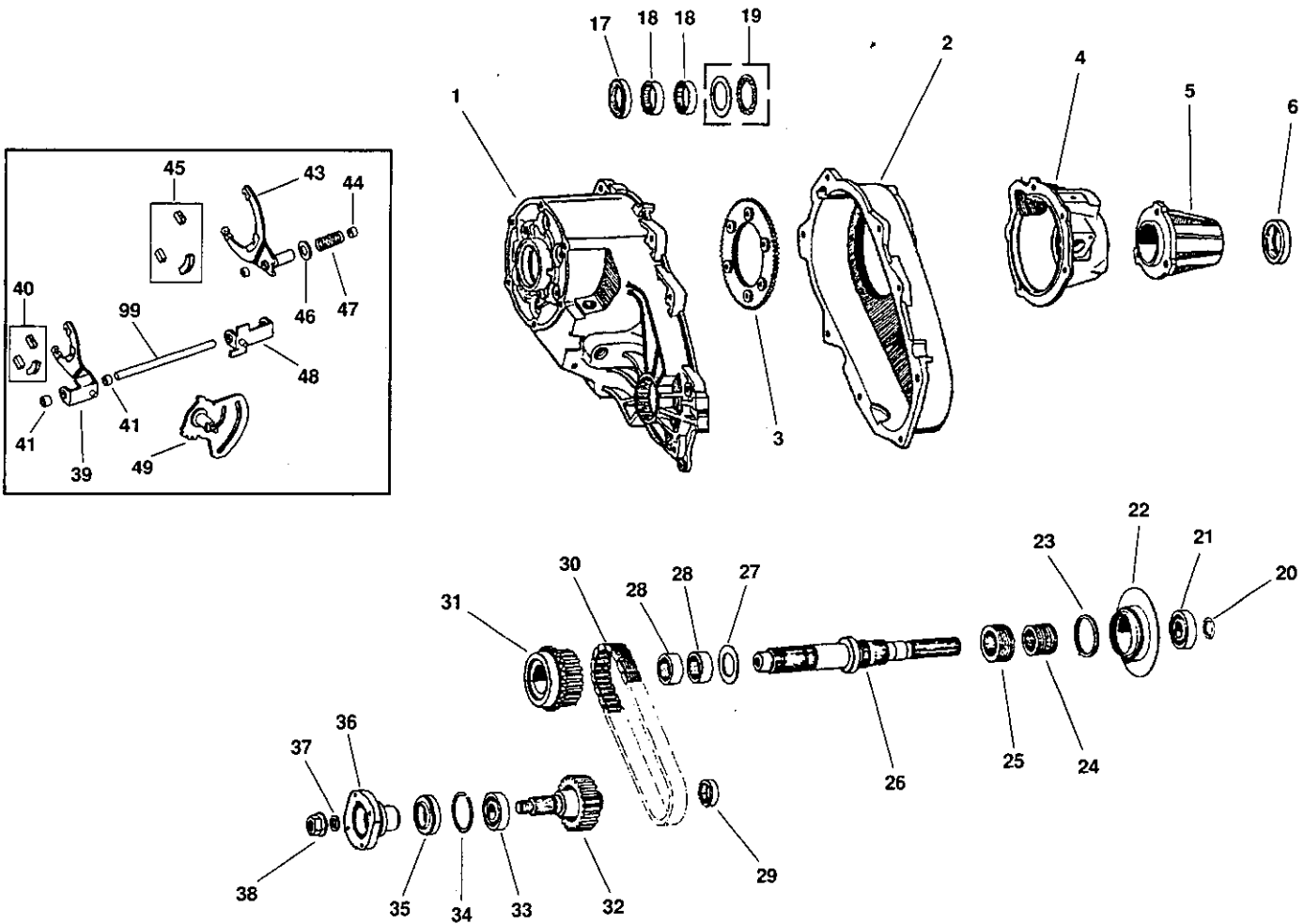
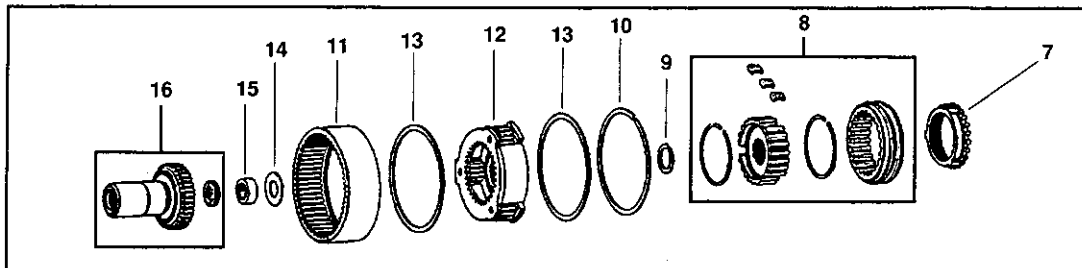

TRANSFER CASE: MODEL 207 & 231

<u>DESCRIPTION</u>	<u>Model 207</u>	<u>Model 231</u>	<u>Model 231</u>
		<u>1987-90</u>	<u>1990</u>
1 CASE, front	83500953 (1)	83503121	53008213
2 CASE, rear	83501192	83503153	83503153
3 PLATE	J8130873		
4 RETAINER	J8134487	83503155	4338949
5 EXTENSION, case	J8134489	83503156	83503156
6 SEAL	83501389	83501389	83501389
7 RING, stop	83500992	83500992	4329526
8 SYNCHRO, mode shift	83502485	83503143	83503143
9 RING, retaining (small)	J8134481	83503144	83503144
10 RING, retaining (large)	J8134454		
11 GEAR, annulus	J8134452	83503122	83503122
12 GEAR, planetary	4446425	83503129 (3)	53006087
13 RING, thrust	J8134456	J8134454	4219065
14 WASHER, thrust	83500993		
15 BEARING	J8134450	J8134450	4338913
16 GEAR, input (25 teeth)	J8134495	83503159 (4)	83506065 (4)
	83500951 (21 teeth)		
17 SEAL, oil	J5359457		
18 BEARING	J8134444		
19 BEARING KIT	J8134451		
20 RING	J8134488	J8134488	J8134488
21 BEARING	J8134445	J8134445	4338892
22 HOUSING, oil pump	J8134486	83503148	4338936
23 SEAL, oil	J8130982	J8130982	J8130982
24 GEAR, speedo. drive	J8134493		
25 PUMP, oil	J8133645		
26 MAINSHAFT	J8134467	83503141	83503141
27 WASHER, thrust	J8134470		
28 BEARING	J8134469	J8130868	4269185
29 BEARING	J8134484	83503154	4269189
30 CHAIN, drive	J8134471	83503146	4338935
31 SPROCKET, drive	J8134468	83503142	4338929
32 SHAFT, output	J8134482	83503145	4338934
33 BEARING	J8134445	J8134445	4338892
34 RING, retaining	J8134447	J8134447	4338894
35 SEAL, oil	J8134446	83503147	4338893
36 FLANGE	53000906 (2)	83503161	83503161
37 WASHER	J8134474	J8134474	J8134474
38 NUT	J8134475	J8134475	J8134475
39 FORK, range shift	J8134459	83503136	4338974
40 PAD KIT, shift fork	83500994	83500994	83500994
41 BUSHING	J8134460	83503137	83503137
42 RAIL, shift	J8134466		
43 FORK, mode shift	J8134461	83503138 (5)	4338920 (5)
44 BUSHING	J8134465		
45 PAD KIT, shift fork	J8134279	J8134279	15866
46 CUP	J8134464		
47 SPRING	J8134463	83503140	4338925
48 BRACKET, shift	J8134462		
49 SECTOR, shift	J8134457		
50 BOLT		83503124	53008215
51 RETAINER KIT		83503135	6500318
52 SEAL		83503133	4338972
53 BEARING		J5359457	4167929
54 SNAP RING		83503123	4338891
55 SNAP RING		83503131	3821558
56 SNAP RING		83503527	4338910
57 THRUST RING		83503526	4338909
		83503130	4338908

MODEL 207 TAG NUMBERS:

53000154
53000421
53000533
53001221
53001224
53001520
53001521
53003735
53003559
53003738
53003390

MODEL 231 (1987-90) TAG NUMBERS:

53003927
53004271
53005382

MODEL 231 (1990) TAG NUMBERS:

53008207
53008212

FOOTNOTES:

(1) With Automatic Transmission use **J8134443**.

(2) With Tag #'s 53003390 thru 53003559 use **83502644**.

(3) With Tag #'s 53006091,92 use **53006087**.

(4) **83503154** use with Tag #'s 53003927, 53004272, 53004328 & 53004301.

83506065 use with Tag #'s 53006093, 53006096, 53008209 & 53008212.

53006083 use with Tag #'s 53006091, 53006092, 53006095, 53006191, 53008207, 53008208 & 53008211.

53006086 use with Tag # 53008223.

(5) Includes Rail.

TRANSFER CASE: MODEL 242

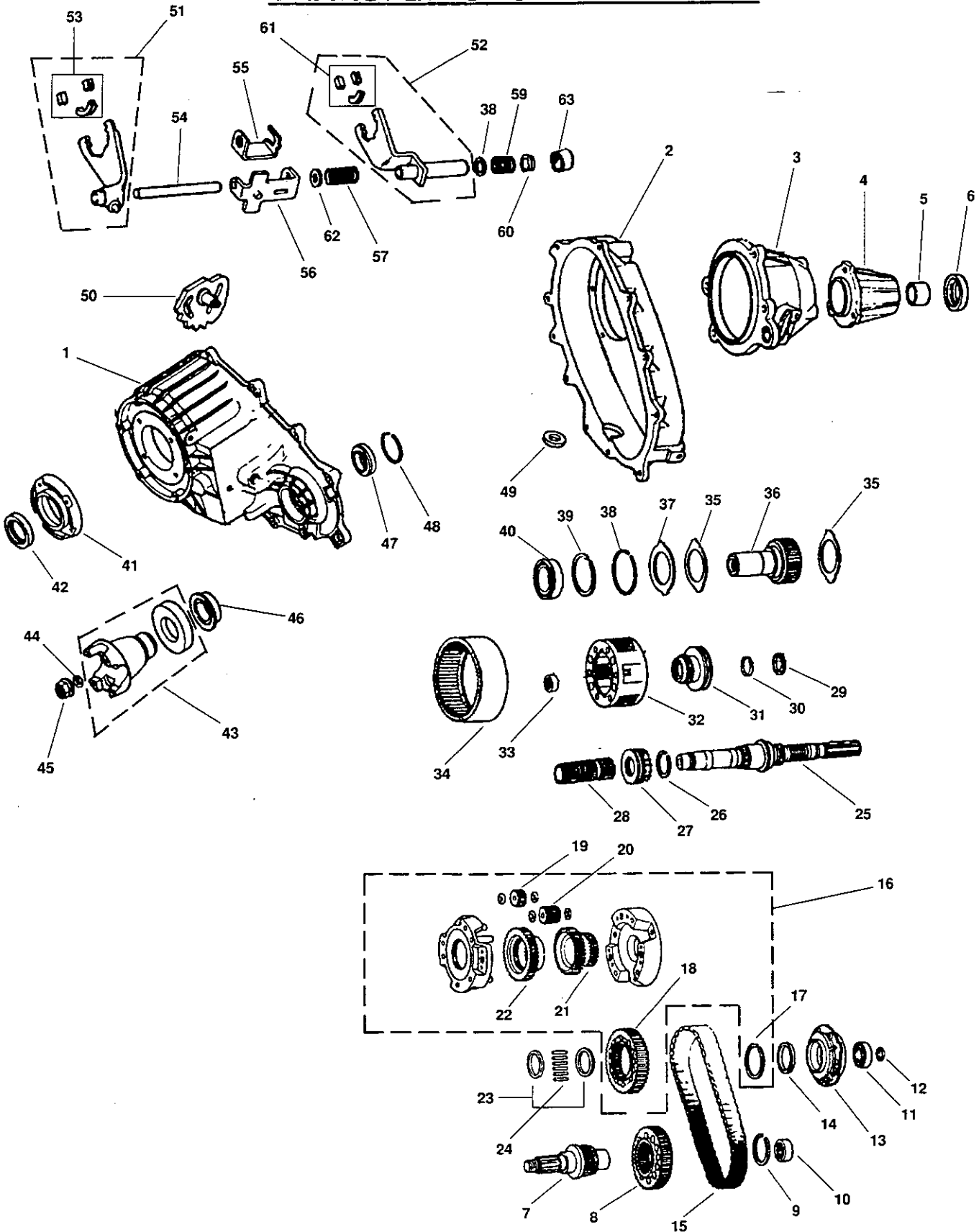

TRANSFER CASE: MODEL 242

<u>DESCRIPTION</u>	<u>1987-89</u>	<u>1990</u>	<u>DESCRIPTION</u>	<u>1987-89</u>	<u>1990</u>
1 CASE, front half	83503500	53008225	51 FORK KIT	83503508	83503508
2 CASE, rear half	83503520	83503520	52 FORK KIT	83503509	83503509
3 RETAINER	83503524	83503524	53 PAD KIT	J8134279	J8134279
4 EXTENSION	83503156	83503156	54 RAIL	83504469	83504469
5 BUSHING	J8134490	J8134490	55 BRACKET, shift	83503511	83503511
6 SEAL	83501389	83501389	56 BRACKET, shift	83503510	83503510
7 SHAFT, front output	83503517	4338991	57 SPRING	83503516	83503516
8 SPROCKET, driven	83503518	83503518	58 WASHER	83503512	83503512
9 SNAP RING	J8130802	J8130802	59 SPRING	83503513	83503513
10 BEARING	83503154	83503154	60 BUSHING	83503514	83503514
11 BEARING	J8134445	4338892	61 PAD SET	83500994	83500994
12 RETAINING RING	J8134488	J8134488	62 CUP	83503515	83503515
13 PUMP, oil	83503148	83503148	63 BUSHING	83503139	83503139
14 SEAL	J8130982	J8130982			
15 CHAIN	83504575	83504575			
16 DIFFERENTIAL ASSY	83503529	83503529			
17 RETAINING RING	83503532	83503532			
18 SPROCKET, drive	83503531	83503531			
19 GEAR, differential	83504170	83504170			
20 GEAR, differential	83504169	83504169	(1) USED W/ TAG #'S : 53004269, 53005464.		
21 SPROCKET	83503530	83503530	(2) USED W/ TAG #'S : 53006097, 53008223, 53008224.		
22 GEAR	83503536	83503536			
23 SPACER	83503533	83503533			
24 ROLLER	83503543	83503543			
25 MAINSHAFT	83503528	83503528			
26 SNAP RING	83503537	83503537			
27 SLEEVE, mode	83503542	83503542			
28 SLEEVE, intermediate	83503538	83503538			
29 WASHER	83503539	83503539			
30 SNAP RING	83503540	83503540			
31 SLEEVE, range mode	83503541	53006090			
32 GEAR, planetary	4338901 (1)	53006087 (2)			
33 BEARING	83503507	83503507			
34 GEAR, annulus	83503122	83503122			
35 WASHER	83503130	4338908			
36 GEAR, input (inc. brg.)	83503506 (1)	53006083 (2)			
37 WASHER, thrust	83503526	83503526			
38 RETAINING RING	83503527	83503527			
39 SNAP RING	83503133	4338972			
40 BEARING	83503123	83503123			
41 RETAINER	83503133	4338972			
42 SEAL	J5359457	J5359457			
43 YOKE ASSY	J8130818	13776			
44 WASHER	83502518	4210973			
45 NUT	J8130816	J8130816			
46 SEAL, rear output	83502798	83502798			
47 BEARING, rear output	83503501	83503501			
48 SNAP RING	83503502	83503502			
49 MAGNET	J8130823	J8130823			
50 BELLCRANK	83503503	83503503			

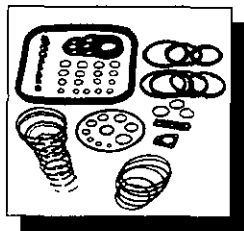

GASKET & SEAL, Overhaul Kit

6 Cyl : SJ, 1979-82 use J8132817
 6 Cyl : SJ, 1983-90 use J8134763
 8 Cyl : SJ, 1979-82 use J8132817
 8 Cyl : SJ, 1983-90 use J8134763

16.035

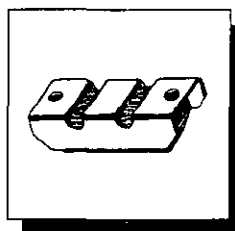

INSULATOR, Transfer Case

6 Cyl : SJ, 1979-89 use J1370910
 8 Cyl : SJ, 1979-89 use J1370910

18.197

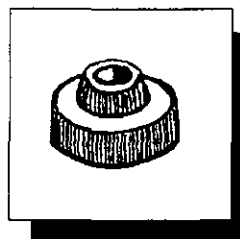

INSULATOR, Transfer Case and Transmission Torque Reaction (Round)

6 Cyl : SJ, 1979-89 use J0945266
 8 Cyl : SJ, 1979-89 use J0945266

18.210

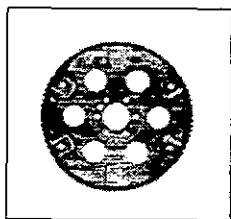

PLATE, Converter Drive (Flex-Plate)

6 Cyl : SJ, 1979-90 use J3232139
 8 Cyl : SJ, 1979-90 use J3232139
 4 Cyl : XJ, 1984-90 use 33003313
 V6 Cyl : XJ, 1984-86 use 53001255
 I6 Cyl : XJ, 1987-90 use 33002675

16.035

PLEASE NOTE:
 FOR DETAILED CHARTS OF
 TRANSFER CASE INTERNAL
 COMPONENTS SEE PAGE TC1 .

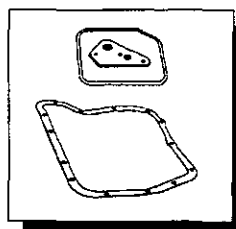

FILTER KIT, including Gasket

6 Cyl : SJ, 1979-89 use J8127652
 6 Cyl : SJ, 1990 use J3515996
 8 Cyl : SJ, 1979-89 use J8127652
 8 Cyl : SJ, 1990 use J3515996
 4 Cyl : XJ, 1984-90 use 83504032
 V6 Cyl : XJ, 1984-86 use 83504032
 I6 Cyl : XJ, 1987-90 use 83504032
 Diesel : XJ, 1984-90 use 83504032

16.345

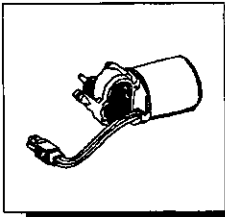

22.027

MOTOR, Windshield Wiper - Front

6 Cyl : SJ, 1979-80 use J5469995
 6 Cyl : SJ, 1981-86 use J5758467
 6 Cyl : SJ, 1987-89 use 56002909
 8 Cyl : SJ, 1979-80 use J5469995
 8 Cyl : SJ, 1981-86 use J5758467
 8 Cyl : SJ, 1987-89 use 56002909

4 Cyl : XJ, 1984-90 use 56001402
 V6 Cyl : XJ, 1984-86 use 56001402
 I6 Cyl : XJ, 1987-90 use 56001402
 Diesel : XJ, 1984-90 use 56001402

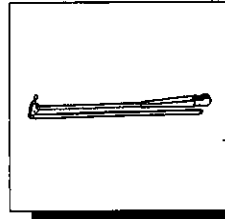

22.044

ARM, Windshield Wiper - Right Front

6 Cyl : SJ, 1979-90 use J5751155
 8 Cyl : SJ, 1979-90 use J5751155

4 Cyl : XJ, 1984-90 use 56001132
 V6 Cyl : XJ, 1984-86 use 56001132
 I6 Cyl : XJ, 1987-90 use 56001132
 Diesel : XJ, 1984-90 use 56001132

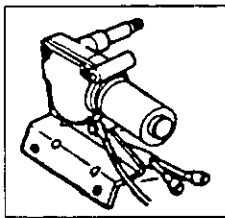

22.027

MOTOR, Windshield Wiper - Rear

4 Cyl : XJ, 1984-90 use 56000701
 V6 Cyl : XJ, 1984-86 use 56000701
 I6 Cyl : XJ, 1987-90 use 56000701
 Diesel : XJ, 1984-90 use 56000701

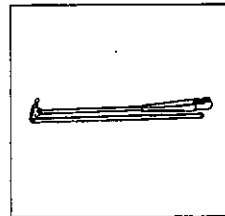

22.044

ARM, Windshield Wiper - Rear

4 Cyl : XJ, 1984-90 use 56000598
 V6 Cyl : XJ, 1984-86 use 56000598
 I6 Cyl : XJ, 1987-90 use 56000598
 Diesel : XJ, 1984-90 use 56000598

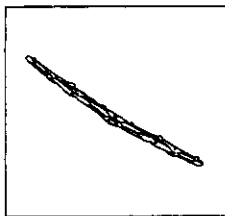

22.043

BLADE, Windshield Wiper

6 Cyl : SJ, 1979-90 use 56002292
 8 Cyl : SJ, 1979-90 use 56002292

4 Cyl : XJ, 1984-90 use 56001133
 V6 Cyl : XJ, 1984-86 use 56001133
 I6 Cyl : XJ, 1987-90 use 56001133
 Diesel : XJ, 1984-90 use 56001133

ALL XJ, 1984-90, Rear use 55000299

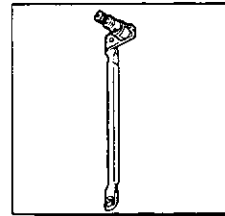

22.047

PIVOT ASSY, Windshield Wiper Shaft (with Rod)

6 Cyl : SJ, 1979-90 use J5758474
 8 Cyl : SJ, 1979-90 use J5758474

4 Cyl : XJ, 1984-90 use 83500660
 V6 Cyl : XJ, 1984-86 use 83500660
 I6 Cyl : XJ, 1987-90 use 83500660
 Diesel : XJ, 1984-90 use 83500660

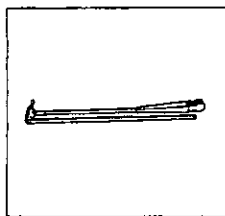

22.044

ARM, Windshield Wiper - Left Front

6 Cyl : SJ, 1979-90 use J5758475
 8 Cyl : SJ, 1979-90 use J5758475

4 Cyl : XJ, 1984-90 use 56001132
 V6 Cyl : XJ, 1984-86 use 56001132
 I6 Cyl : XJ, 1987-90 use 56001132
 Diesel : XJ, 1984-90 use 56001132

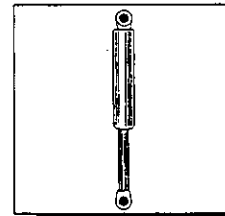

23.405

SUPPORT ROD, Rear Liftgate

4 Cyl : XJ, 1984-90 use 55000630
 V6 Cyl : XJ, 1984-86 use 55000630
 I6 Cyl : XJ, 1987-90 use 55000630
 Diesel : XJ, 1984-90 use 55000630

A

ACCELERATOR CABLE, 24
ADJUSTER, CLUTCH WEAR 32
ADJUSTER KIT, BRAKE AUTOMATIC 36
AIR CLEANER ELEMENT, 25
ALTERNATOR, 14
ARM
 STEERING LINKAGE PITMAN, 60
 VALVE ROCKER, 6
 WINDSHIELD WIPER, 70
ARMATURE, STARTER 14
AXLE GEAR SET, FRONT AXLE 56
AXLE PINION YOKE, 53
AXLE SHAFT
 FRONT DRIVE 57
 REAR 48

B

BALL, CLUTCH THROWOUT LEVER 31
BEARING
 CLUTCH PEDAL, 32
 CONNECTING ROD, 8
 FRONT AXLE PINION, 56
 FRONT WHEEL, 39
 MAIN, 1
 REAR AXLE DIFFERENTIAL SIDE, 46
 REAR AXLE PINION, 47
 REAR WHEEL, 40
BEARING KIT
 FRONT AXLE DIFFERENTIAL SIDE, 55
 FRONT AXLE PINION, 57
 REAR AXLE DIFFERENTIAL, 46
 REAR AXLE PINION, 47
 STEERING SPINDLE, 59
 WHEEL, 40
BEARING SET, CAMSHAFT 2
BELLCRANK, CLUTCH RELEASE IDLER 32
BELT
 CRANKSHAFT TO EXHAUST EMISSION PUMP, 28
 POWER STEERING PUMP, 61
 RADIATOR & ALTERNATOR FAN, 11
 SERPENTINE DRIVE, 11
BELT SET, DUAL BELT DRIVE 12
BEZEL, HEADLAMP 17
BLADE, WINDSHIELD WIPER 70
BLADES, FAN 11
BLEEDER SCREW
 BRAKE WHEEL CYLINDER, 37
 CALIPER, 43
BOLT
 BRAKE HOUSING RETAINER, 42
 PIVOT TO CYLINDER HEAD, 6
 WHEEL, 39
BOOT
 CLUTCH PIVOT, 32
 FLOOR GEAR SHIFT LEVER, 35
 TRANSMISSION & TRANSFER CASE SHIFT LEVER, 35
BRACKET
 FRONT SHOCK TO FRAME, 66
 REAR BUMPER MOUNTING, 67
BRAKE AUTOMATIC ADJUSTER KIT, 36
BRAKE CABLE
 EQUALIZER TO REAR CABLE, 38
 TO REAR WHEELS, 38
BRAKE DISC ASSY, FRONT WHEEL 41
BRAKE DRUM, REAR 38

BRAKE HOSE, FRONT WHEEL DISC 43
BRAKE MASTER CYLINDER REPAIR KIT, 41
BRAKE PAD SET
 FRONT WHEEL, 42
 REAR BRAKE, 36
BRAKE PEDAL BUSHING, 37
BRAKE PEDAL PAD, 37
BRAKE SHOE HOLD DOWN & SPRING KIT, 36
BRAKE TUBE HOSE, 37
BRAKE WHEEL CYLINDER ASSY, 36
BRAKE WHEEL CYLINDER BLEEDER SCREW, 37
BRIDGE, ROCKER ARM 6
BRUSH KIT, STARTER 15
BUMPER
 CAPS, 67
 FRONT, 67
 FRONT AXLE, 54
 REAR AXLE, 49
 REAR MOUNTING BRACKET, 67
BUSHING
 BRAKE PEDAL, 37
 CRANKSHAFT, 2
 FRONT SPRING, 64
 LEAF SPRING SHACKLE, 65
 PILOT, 2
 REAR SPRING, 65
 SHOCK ABSORBER MOUNTING, 66
 STARTER DRIVE END, 15

C

CABLE
 ACCELERATOR, 24
 EQUALIZER TO REAR CABLE, 38
 FOOT OPERATED PARKING BRAKE TO EQUALIZER, 38
 FRONT FENDER SIDE LAMP, 23
 SPEEDOMETER, 20
 TEMPERATURE CONTROL, 68
 TO REAR WHEELS, 38
CALIPER ASSY, FRONT WHEEL DISC BRAKE 42
CAMSHAFT, 2
CAP
 DISTRIBUTOR, 15
 FRONT BUMPER RAIL, 67
 FRONT WHEEL GREASE, 40
 NON-LOCKING GAS TANK FILLER, 26
 OIL FILLER, 1
 RADIATOR, 12
 TRANSMISSION CONTROL HOUSING, 35
CARBURETOR, 24
CARBURETOR FLOAT, 24
CARBURETOR REPAIR KIT, 29
CASE
 FRONT AXLE DIFFERENTIAL, 55
 REAR AXLE DIFFERENTIAL, 45
CASE ASSY
 FRONT AXLE DIFFERENTIAL, 55
 REAR AXLE DIFFERENTIAL, 44
CLIP, BRAKE TUBE FASTENING 37
CLUTCH COVER, 31
CLUTCH DRIVEN PLATE, 31
CLUTCH FORK RELEASE ROD ASSY, 32
CLUTCH MASTER CYLINDER, 33
CLUTCH MASTER CYLINDER HOSE, 33
CLUTCH MASTER CYLINDER REPAIR KIT, 33
CLUTCH PEDAL BEARING, 32
CLUTCH PEDAL PAD, 32
CLUTCH PEDAL SPRING, 32

CLUTCH PIVOT BOOT, 32
CLUTCH RELEASE IDLER BELLCRANK, 32
CLUTCH RELEASE IDLER PIVOT, 32
CLUTCH SLAVE CYLINDER, 33
CLUTCH THROWOUT LEVER, 31
CLUTCH THROWOUT LEVER BALL, 31
CLUTCH THROWOUT LEVER SLEEVE, 31
CLUTCH THROWOUT LEVER SPRING, 33
CLUTCH THROWOUT PIVOT ASSY, 31
CLUTCH THROWOUT SPRING, 31
CLUTCH WEAR ADJUSTER, 32
COIL, IGNITION 16
COIL WIRE, IGNITION 17
COOLANT SENSOR, 21
CORE
 HEATER, 68
 RADIATOR, 12
COVER
 CLUTCH, 31
 CYLINDER HEAD, 4
 FLOOR GEAR SHIFT LEVER, 34
 FRONT AXLE HOUSING, 54
COVER KIT, CYLINDER HEAD 4
CUP
 FRONT AXLE PINION BEARING, 56
 FRONT WHEEL INNER, 39
 FRONT WHEEL RETAINER SPRING, 40
 REAR AXLE DIFFERENTIAL SIDE, 46
 REAR AXLE PINION, 47
 REAR WHEEL BEARING, 40
CUSHION, FRONT SUSPENSION SWAY STABILIZER 61
CYLINDER, IGNITION SWITCH 16
CYLINDER ASSY
 POWER BRAKE MASTER, 41
 REAR BRAKE WHEEL, 36
CYLINDER HEAD COVER, 4
CYLINDER HEAD COVER KIT, 4

D
DAMPER, STEERING 61
DAMPER KIT, EXHAUST MANIFOLD 4
DIFFERENTIAL BEARING KIT, FRONT AXLE 55
DIFFERENTIAL CASE
 FRONT AXLE, 55
 REAR AXLE, 45
DIFFERENTIAL CASE ASSY
 FRONT AXLE, 55
 REAR AXLE 44
DIFFERENTIAL GEAR SET
 FRONT AXLE, 55
 REAR AXLE, 45
DIFFERENTIAL SHIM SET, FRONT AXLE, CASE SIDE BEARING 55
DIRECTIONAL SIGNAL FLASHER, 19
DIRECTIONAL SWITCH, 19
DISC ASSY, FRONT WHEEL BRAKE 41
DISC KIT, REAR AXLE DIFFERENTIAL CLUTCH FRICTION 46
DISTRIBUTOR, 15
DRAINCOCK, RADIATOR CORE 12
DRIVE ASSY, STARTER 14
DRUM, REAR BRAKE 38

E
ELEMENT
 AIR CLEANER, 25
 OIL FILTER, 10
EXHAUST PIPE, 26

F
FENDER ASSY, FRONT 67
FILTER
 AIR, 25
 CYLINDER HEAD COVER TO AIR CLEANER HOSE, 6
 FUEL TANK, 26
 FUEL VAPOR STORAGE CANISTER, 26
 OIL, 10
FILTER KIT
 FUEL PUMP LINE, 25
 TRANSFER CASE, 69
FLANGE, FRONT AXLE SHAFT DRIVE 58
FLASHER
 DIRECTIONAL SIGNAL, 19
 HAZARD WARNING, 22
FLOAT, CARBURETOR 24
FLYWHEEL RING GEAR, 2
FRONT AXLE
 BUMPER, 54
 DIFFERENTIAL & PINION SHIM SET, 56
 DIFFERENTIAL CASE, 55
 DIFFERENTIAL CASE ASSY, 55
 DIFFERENTIAL SHIM SET, 55
 DIFFERENTIAL SIDE BEARING KIT, 55
 DIFFERENTIAL SIDE GEAR SET, 55
 GEAR SET, 56
 HOUSING COVER, 54
 HOUSING COVER GASKET, 54
 INNER SEAL, 58
 PINION BEARING, 56
 PINION BEARING CUP, 56
 PINION BEARING DUST SLINGER, 57
 PINION BEARING KIT, 57
 PINION BEARING OIL SEAL, 57
 PINION BEARING OIL SLINGER, 57
 PINION NUT, 56
 PINION SHIM SET, 56
 PINION YOKE, 53
 SHAFT ASSY, 57
 SHAFT DRIVE FLANGE, 58
 SHAFT OUTER SNAP RING, 58
 SHAFT UNIVERSAL JOINT, 58
 TRANSFER CASE REAR OUTPUT YOKE, 53
FRONT SPRING BUSHING, 64
FUEL GAUGE, 22
FUEL INJECTOR, 30
FUEL INJECTOR SEAL KIT, 30
FUEL PUMP, 25
FUEL PUMP FILTER KIT, 25
FUEL PUMP GASKET, 25
FUEL TANK ASSY, 25
FUEL TANK FILLER CAP, 26
FUEL TANK FILTER, 26
FUEL VAPOR CANISTER FILTER, 26
FUSE, 17

G
GAS TANK ASSY, 25
GASKET
 CYLINDER HEAD, 3
 ENGINE OIL PUMP COVER, 10
 EXHAUST MANIFOLD DAMPER, 4
 EXHAUST MANIFOLD TO CYLINDER HEAD, 4
 FRONT AXLE HOUSING COVER, 54
 FUEL GAUGE TO TANK, 22
 FUEL PUMP, 25

INTAKE MANIFOLD TO CYLINDER HEAD, 3
 INTAKE MANIFOLD TO EXHAUST MANIFOLD, 3
 REAR AXLE HOUSING COVER, 44
 THERMOSTAT HOUSING, 13
 WATER PUMP, 13
GASKET & SEAL KIT, TRANSFER CASE OVERHAUL 69
GASKET SET
 ENGINE LOWER, 3
 ENGINE OIL PAN, 9
 ENGINE VALVE GRIND, 3
GAUGE
 FUEL, 22
 OIL PRESSURE, 21
 WATER TEMPERATURE, 21
GEAR, FLYWHEEL RING 2
GEAR & PINION GEAR SET, REAR AXLE RING 46
GEAR ASSY, STEERING 61
GEAR SET
 FRONT AXLE, 56
 FRONT AXLE DIFFERENTIAL SIDE, 55
 REAR AXLE DIFFERENTIAL, 45
 REAR AXLE RING GEAR & PINION, 46

H

HAZARD WARNING FLASHER, 22
HEADLAMP BEZEL, 17
HEADLAMP RETAINING RING, 18
HEATER & DEFROSTER MOTOR, 68
HEATER CORE, 68
HOLD DOWN & SPRING KIT, BRAKE SHOE 36
HOOD ASSY, 67
HORN, LOW PITCH 16
HOSE
 BRAKE TUBE, 37
 CLUTCH MASTER CYLINDER TO CLUTCH SLAVE CYLINDER, 33
 FRONT WHEEL DISC BRAKE, 43
 RADIATOR INLET, 13
 POWER STEERING PUMP, 62
 RADIATOR OUTLET, 12
 WATER PUMP TO THERMOSTAT HOUSING BYPASS, 13
HOUSING, THERMOSTAT 13
HUB ASSY, FRONT WHEEL 39

I

IGNITION COIL, 16
IGNITION COIL WIRE, 17
IGNITION SWITCH, 16
IGNITION WIRE SET, 17
IGNITION WIRE SHIELD, 17
INJECTOR, FUEL 30
INSULATOR
 FRONT ENGINE MOUNTING, 1
 MUFFLER & TAIL SUPPORT, 27
 TAILPIPE SUPPORT, 28
 TRANSFER CASE, 69

K

KNUCKLE, STEERING 59

L

LAMP
 FRONT SIDE MARKER, 23
 LICENSE PLATE, 19

PARKING & FRONT DIRECTIONAL, 18
 REAR SIDE MARKER, 23
LAMP ASSY, TAIL, STOP & REAR 18
LEAF SPRING ASSY
 FRONT, 63
 REAR, 63
LEAF SPRING SHACKLE, 65
LENS
 PARKING & FRONT DIRECTIONAL, 18
 TAIL & STOP LAMP, 19
LEVER
 CLUTCH THROWOUT, 31
 FLOOR GEAR SHIFT, 34
LICENSE PLATE LAMP, 19
LIFTGATE, SUPPORT ROD 70
LINK, FRONT SUSPENSION SWAY STABILIZER 61
LOCK, FUEL TANK 22

M

MASTER CYLINDER
 CLUTCH, 33
 POWER BRAKE, 41
MIRROR HEAD, OUTSIDE REAR VIEW 68
MODULE, SOLID STATE IGNITION 16
MOTOR
 HEATER & DEFROSTER, 68
 STARTING, 14
 WINDSHIELD WIPER, 70
MOTOR KIT, IDLE AIR BY-PASS 30
MOUNT. See Insulator: front engine mounting
 MUFFLER & TAIL SUPPORT, 27
 TAILPIPE SUPPORT, 28
 TRANSFER CASE, 69
MUFFLER, 27

N

NUT
 FRONT AXLE PINION, 56
 FRONT WHEEL BEARING RETAINER, 40
 REAR AXLE PINION, 47

O

OIL PRESSURE GAUGE, 21
OIL PRESSURE SENDING UNIT, 21
OIL SEAL
 FRONT AXLE PINION BEARING, 57
 FRONT STEERING SPINDLE, 59
 REAR AXLE, 49
 REAR AXLE PINION BEARING, 48
OVERHAUL KIT, TRANSFER CASE GASKET & SEAL 69
OXYGEN SENSOR, 28

P

PAD
 BRAKE PEDAL, 37
 CLUTCH PEDAL, 32
PAD KIT, FRONT BRAKE SHOE, 42
PARKING & FRONT DIRECTIONAL LAMP, 18
PARKING & FRONT DIRECTIONAL LENS, 18
PARKING BRAKE CABLE, FOOT OPERATED TO EQUALIZER 38
PCV VALVE, 6
PIN, FLOOR GEAR SHIFT LEVER FULCRUM 34
PIPE, EXHAUST 26

PISTON

DISC BRAKE CALIPER, 42
ENGINE, WITH PIN, 8

PITMAN ARM, 60

PIVOT

CLUTCH RELEASE IDLER, 32
VALVE ROCKER ARM, 6

PIVOT ASSY

CLUTCH THROWOUT, 31
WINDSHIELD WIPER SHAFT, 70

PLATE

CLUTCH DRIVEN, 31
FRONT LEAF SPRING TO AXLE TIE, 63
PRESSURE, 31
REAR LEAF SPRING TO AXLE TIE, 64
TRANSFER CASE CONVERTER DRIVE, 69

PLUG, CYLINDER BLOCK 2

PRESSURE PLATE, 31

PROPELLER SHAFT, 50

PROPELLER SHAFT SPIDER ASSY, 54

PROPELLER SHAFT YOKE, FRONT CENTER 54

PUMP ASSY

ENGINE OIL, 10
WATER, 13

PUSH ROD, 6

R

RADIATOR, 12

RAIL, FRONT BUMPER 67

RAIL ASSY, MULTI PORT INJECTION 30

REAR AXLE

BUMPER, 49
DIFFERENTIAL BEARING KIT, 46
DIFFERENTIAL CASE, 45
DIFFERENTIAL CASE ASSY, 44
DIFFERENTIAL CLUTCH DISC KIT, 46
DIFFERENTIAL GEAR SET, 45
DIFFERENTIAL SIDE BEARING, 46
DIFFERENTIAL SIDE CUP, 46
HOUSING COVER GASKET, 44
OIL SEAL, 49
PINION ADJUSTING SHIM SET, 48
PINION BEARING, 47
PINION BEARING KIT, 47
PINION BEARING OIL SEAL, 48
PINION CUP, 47
PINION NUT, 47
PINION SPACER, 48
RING GEAR & PINION GEAR SET, 46
SHAFT, 48

REAR SPRING BUSHING, 65

REGULATOR KIT, PRESSURE 30

RELAY

HORN, 16
STARTING MOTOR, 15

REPAIR KIT

CARBURETOR, 29
CLUTCH MASTER CYLINDER, 33
DISC BRAKE PISTON HOUSING, 42
POWER BRAKE MASTER CYLINDER, 41
REAR WHEEL CYLINDER, 37

RETAINER

FLOOR GEAR SHIFT LEVER FULCRUM SPRING, 34
FRONT WHEEL GREASE, 39
REAR WHEEL BEARING, 40

RING

HEADLAMP RETAINING, 18
REAR AXLE BEARING RETAINING, 41

RING SET, PISTON 9

ROCKER ARM, 6

ROD

LIFTGATE SUPPORT, 70
VALVE PUSH, 6

ROD ASSY

CLUTCH FORK RELEASE, 32
CONNECTING, 8

ROTOR, DISTRIBUTOR 16

S

SCREW KIT, BRAKE ADJUSTING 36

SEAL

ENGINE OIL PAN TO BEARING CAP, 9
EXHAUST PIPE TO MANIFOLD, 27
FRONT AXLE INNER, 58
FRONT AXLE PINION BEARING OIL, 57
OIL PAN TIMING CASE COVER, 10
REAR AXLE BEARING, 41
REAR AXLE OIL, 49
REAR AXLE PINION BEARING OIL, 48

SEAL KIT

FUEL INJECTOR, 30
REAR MAIN BEARING CAP, 2

SENDING UNIT

FUEL, 22
OIL PRESSURE, 21
WATER TEMPERATURE, 21

SENSOR

AIR TEMPERATURE, 21
COOLANT, 21
OXYGEN, 28

SENSOR KIT, THROTTLE BODY 30

SHACKLE, LEAF SPRING 65

SHACKLE BUSHING, LEAF SPRING 65

SHAFT

PROPELLER, 50
REAR AXLE, 48

SHAFT ASSY, FRONT AXLE DRIVE 57

SHIELD, IGNITION WIRE 17

SHIM SET

FRONT AXLE DIFFERENTIAL & PINION, 56
FRONT AXLE DIFFERENTIAL CASE SIDE BEARING, 55
FRONT AXLE PINION, 56
REAR AXLE PINION ADJUSTING, 48

SHOCK ASSY

FRONT, 65
REAR SPRING, 66

SHOE SET

FRONT WHEEL DISC BRAKE, 42
REAR BRAKE, 36

SLAVE CYLINDER, CLUTCH 33

SLEEVE, CLUTCH THROWOUT LEVER 31

SLINGER

FRONT AXLE PINION BEARING DUST, 57
FRONT AXLE PINION BEARING OIL, 57

SNAP RING, FRONT AXLE SHAFT OUTER 58

SPACER

FRONT STEERING SPINDLE, 59
REAR AXLE PINION, 48

SPEEDOMETER

KILOS, 20
MILES, 20

SPIDER ASSY, PROPELLER SHAFT 54

SPINDLE ASSY, STEERING 59

SPRING

- BRAKE SHOE SUPPORT, 42
- CLUTCH PEDAL, 32
- CLUTCH THROWOUT, 31
- CLUTCH THROWOUT LEVER, 33
- FLOOR GEAR SHIFT LEVER FULCRUM, 34

SPRING ASSY

- FRONT LEAF, 63
- REAR LEAF, 63

SPROCKET

- CAMSHAFT, 8
- CRANKSHAFT, 8

STEERING

- DAMPER, 61
- GEAR ASSY, 61
- KNUCKLE, 59
- KNUCKLE BALL STUD, 59
- KNUCKLE BALL STUD KIT, 59
- LINKAGE PITMAN ARM, 60
- SPINDLE ASSY, 59
- SPINDLE BEARING KIT, 59

STOP LAMP SWITCH, 19

STUD

- FRONT WHEEL DISC BRAKE DISC ASSY TO WHEEL, 41
- STEERING KNUCKLE BALL, 59

STUD KIT, STEERING KNUCKLE BALL 59

SUPPORT ROD, REAR LIFTGATE 70

SWITCH

- DIRECTIONAL, 19
- HEADLIGHT DIMMER, 17
- IGNITION, 16
- LIGHTING, 16
- STOP LAMP, 19

T

TACHOMETER, 22

TAIL LAMP ASSY, 18

TAIL LAMP LENS, 19

TAILPIPES, 27

TAPPET, VALVE 6

TEMPATROL, 11

THERMOSTAT, 13

TIE ROD ASSY

- PITMAN ARM TO STEERING ARM, 60
- STEERING ARM TO STEERING ARM, 60

TIE ROD END ASSY

- PITMAN ARM TO STEERING ARM, 60
- STEERING ARM TO STEERING ARM, 60

TRACK BAR, 60

TRANSFER CASE

- CONVERTER DRIVE PLATE, 69
- FILTER KIT, 69
- FRONT OUTPUT YOKE, 53
- INSULATOR, MOUNT, 69
- OVERHAUL GASKET & SEAL KIT, 69
- REAR OUTPUT YOKE, 53

TUBE

- AIR CLEANER DUCT, 24
- COLD AIR INDUCTION, 25

U

U-BOLT

- FRONT SPRING, 63
- REAR SPRING, 64

UNIVERSAL JOINT, FRONT AXLE SHAFT 58

V

VALVE

- EXHAUST EMISSION BACK-FIRE, 28
- INTAKE, 4
- PCV, 6

VOLTMETER, 21

W

WASHER, FRONT WHEEL BEARING LOCK 40

WATER PUMP, 13

WATER TEMPERATURE GAUGE, 21

WATER TEMPERATURE SENDING UNIT, 21

WHEEL CYLINDER ASSY, REAR BRAKE 36

WHEEL CYLINDER REPAIR KIT, 37

WINDSHIELD WIPER

- ARM, 70
- BLADE, 70
- MOTOR, 70
- SHAFT PIVOT ASSY, 70

WIRE SET, IGNITION 17

Y

YOKE

- AXLE PINION, 53
 - FRONT PROPELLER SHAFT, 54
 - FRONT PROPELLER SHAFT UNIVERSAL JOINT SLEEVE, 53
 - REAR PROPELLER SHAFT UNIVERSAL JOINT SLEEVE, 53
 - TRANSFER CASE FRONT OUTPUT, 53
 - TRANSFER CASE REAR OUTPUT, 53
- YOKE KIT, FRONT PROPELLER SHAFT 54**

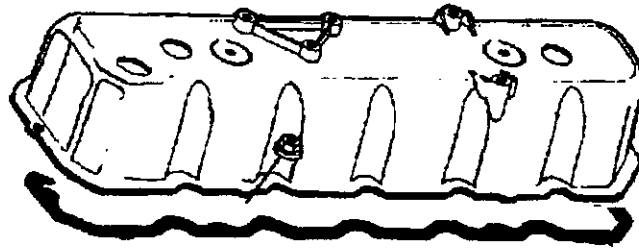

ENGINE VALVE COVER KIT

NO DRILLING. No special glue or time wasted during "curing period".

NO WONDERING, "Will it work?"

OUR NEW KIT solves the problem **FAST.**

PART NO. : 8983501398K

DESCRIPTION : Includes Cover, special gasket that seals and insulates at the same time and hardware.

APPLICATION : 1981 & Up All 6 Cylinder 258's.

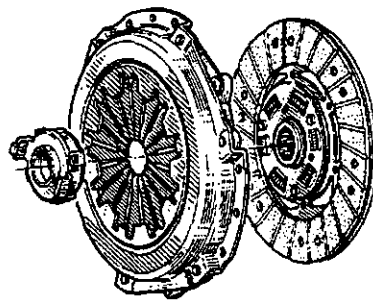

CLUTCH KIT

<u>PART NO.</u>	<u>APPLICATION</u>
5357437K	1978-81 'J' Series w/ 6-258, 11"
3240278K	All 1982 & Up 6-258 w/ 10 1/2 "
53004538K	1987-88 XJ w/ 2.5L 4 Cylinder
53004116K	1987-88 XJ w/ 4.0L 6 Cylinder
83500806K	All XJ w/ 2.8L V6

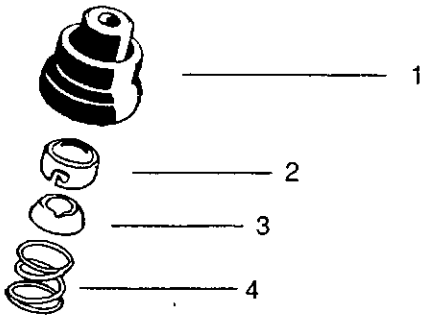

SHIFT LEVER REPAIR KIT : T176 TRANS

PART NO. : SLR-176

DESCRIPTION : Includes Boot (1), Cap (2), Cap Spring (3) and Spring (4).

APPLICATION : ALL T176 Transmissions.

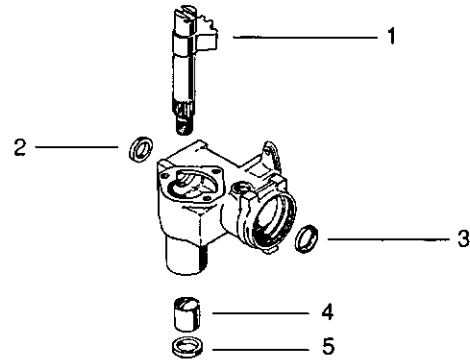

SECTOR SHAFT KIT

PART NO. : 8120221K

DESCRIPTION : Includes Shaft (1), Seal (2), Cup (3), Bushing (4) and Seal (5).

APPLICATION : ALL Manual Transmissions.

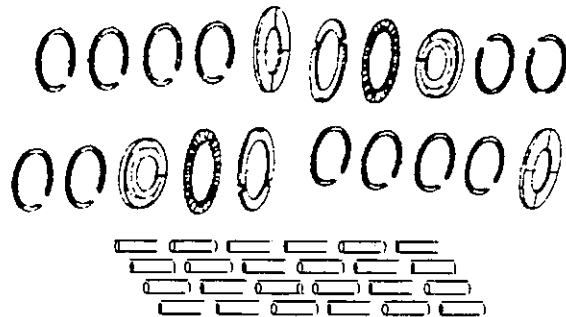

TRANSMISSION KITS

<u>PART NO.</u>	<u>DESCRIPTION</u>	<u>APPLICATION</u>
T4-50	Small Parts Kit	T4 1981 & Up 4 Speed
T5-50	Small Parts Kit	T5 1981 & Up 5 Speed
T170-50	Small Parts Kit	4 Speed Tremec T176, 177 & 178
T170-GS	Gasket & Seal Set	4 Speed Tremec T176, 177 & 178

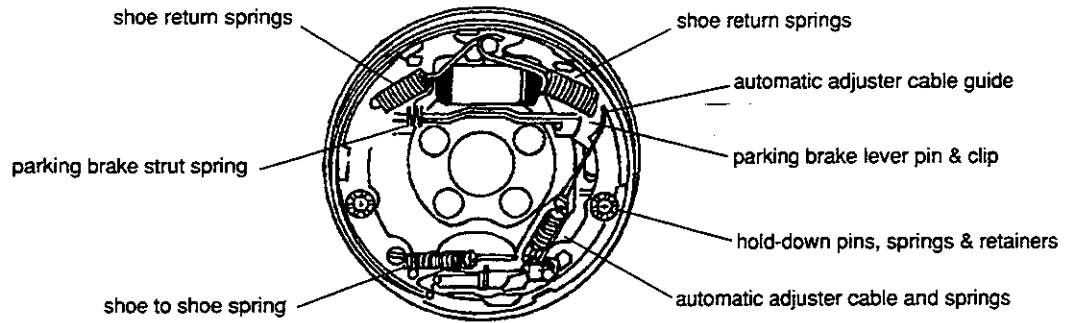

BRAKE KIT

<u>PART NO.</u>	<u>APPLICATION</u>
4636775	Grand Wagoneer & J10 Pickup with DANA 44 Axle
4636776	J-20 Pickup with DANA 60 Axle
4636777	CJ's 1978-86 with DANA 20 Axle Wrangler & XJ with DANA 35, with & w/o Anti-Lock Brakes
4636778	Wrangler, XJ & CJ-5,7,8 with DANA 44 Axle
4636779	Wrangler & XJ with DANA 35 Axle

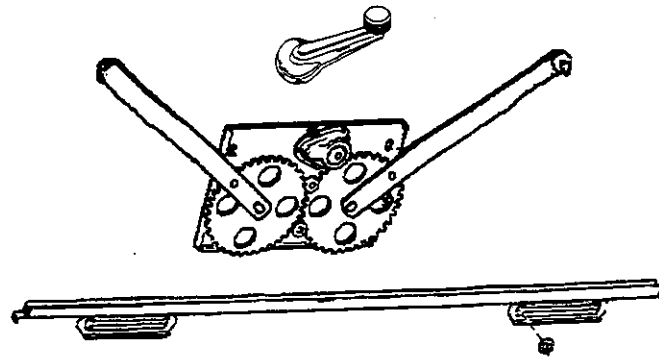

MANUAL REAR WINDOW REGULATOR KIT

PART NO. : 974016K

DESCRIPTION : Includes All You Need to Convert Electric to Manual!

APPLICATION : All Wagoneers.



MAIN OFFICE

340 Oak Street
North Pembroke, MA 02358

(781) 826-6200 (800) 343-9666

FAX # (781) 826-4097

WESTERN BRANCH

161 S. Kernite Street
Tooele, UT 84074

TOLL FREE (800) 453-8220

FAX # (800) 795-2476

SOUTHERN BRANCH

955 Hurricane Shoals Road, Suite 101
Lawrenceville, GA 30243

(404) 339-0862 (800) 241-9462

FAX # (800) 221-5957

Crown Automotive Sales Co., Inc.

Independent Distributor of Replacement Parts for Jeep® Vehicles